



Sistemas de Control  
Edificios inteligentes

## **ChillerVu chilled water system opt. OPN-OPT-OL**



### **Guía de Instalación**

Brindamos soluciones tecnológicas de calidad.  
Contribuimos a desarrollar y mejorar los sistemas para operación de edificios existentes.  
Mejoramos soluciones desarrolladas incorporando nuevas tecnologías y procesos de manera continua.

**EXPERTOS EN CONTROLES**

[www.anzures.com.ar](http://www.anzures.com.ar)



**Vidal 4819 PB**  
**C1429AIM - Ciudad Autónoma de Buenos Aires**

**Tel. 011-3529-4390**  
**Email: [ivupro@anzures.com.ar](mailto:ivupro@anzures.com.ar)**  
**web: [www.anzures.com.ar](http://www.anzures.com.ar)**

# Chilled Water System Optimizer v2 Installation and Start-up Guide

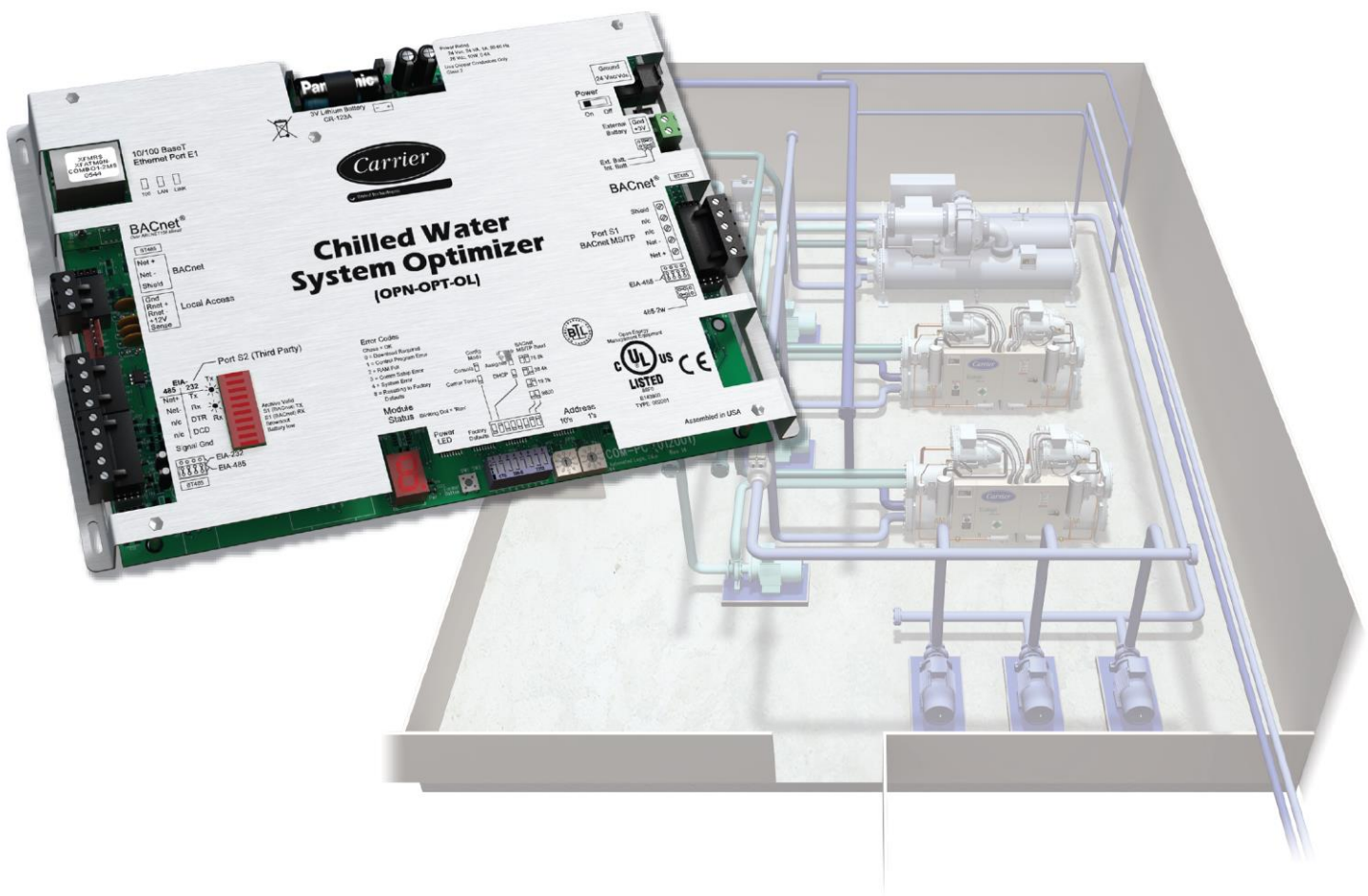



Verify that you have the most current version of this document from [www.hvacpartners.com](http://www.hvacpartners.com) or your local Carrier office.

Important changes are listed in **Document revision history** at the end of this document.

CARRIER CORPORATION ©2019. All rights reserved throughout the world. i-Vu is a registered trademark of Carrier Corporation. All other trademarks are the property of their respective owners.



# Contents

<b>What is the Chilled Water System Optimizer?</b> .....	<b>1</b>
Specifications .....	2
Chiller system configurations .....	3
Installation overview .....	5
Safety considerations.....	6
<b>Installing the Chilled Water System Optimizer</b> .....	<b>7</b>
To mount the controller .....	7
Wiring the controller for power.....	7
To wire for power.....	8
<b>Addressing the controller</b> .....	<b>9</b>
To set the controller address on the Open network .....	9
To choose an IP addressing scheme .....	10
To obtain an IP address using DHCP .....	10
To assign a custom IP address.....	10
<b>Wiring for communications</b> .....	<b>13</b>
Ethernet wiring specifications .....	13
To wire to the BACnet over IP network (DHCP).....	14
To wire to a BACnet over IP network (assign a custom IP) .....	14
<b>Wiring for third party protocols</b> .....	<b>16</b>
To wire Modbus devices on Port S2.....	16
To wire a third-party device .....	17
<b>Communicating through the Local Access port with a USB Link</b> .....	<b>18</b>
To communicate using PuTTY .....	19
<b>Installing the controller into an i-Vu® Control System</b> .....	<b>21</b>
To configure third party protocols in the i-Vu® interface .....	22
<b>To set up the driver</b> .....	<b>23</b>
Driver .....	23
Notification Classes.....	24
Calendars .....	25
Common and Specific Alarms .....	26
Custom Translation Tables.....	26
BACnet firewall.....	26
Protocols .....	27
<b>Troubleshooting</b> .....	<b>28</b>
Controller LED's.....	28
To restore factory defaults .....	29
To get the serial number .....	30
To replace the controller's battery .....	30
To take the controller out of service .....	30
<b>Start-up and Commissioning</b> .....	<b>31</b>
Network Points.....	31
General conditions and status.....	32
Chilled water temperature optimizer reset .....	34
Chilled water optimizer reset - Start-up.....	36
Chilled water optimizer reset - Tuning.....	37
Condenser water optimizer reset .....	39
Condenser water optimizer reset - Start-up.....	41
Condenser water optimizer reset - Tuning.....	42
<b>Device Address Binding</b> .....	<b>45</b>

<b>Configuring the Chilled Water System Optimizer's Properties page</b> .....	<b>47</b>
<b>Compliance</b> .....	<b>48</b>
CE Compliance .....	48
FCC Compliance .....	48
BACnet Compliance.....	48
<b>Appendix A: The Chilled Water System Optimizer – Status only view of the Properties page</b> .....	<b>49</b>
General Conditions & Status.....	50
Section 1 - Optimizer - Primary Enable Conditions.....	50
Section 2 - Chiller System Power, Efficiency, and Thermal Load Input Status .....	51
Section 3 - Stagger Reset - Enable Conditions.....	52
Chilled Water Temperature Optimizer Reset .....	53
Section 1 - Chilled Water System Optimizer - Enable conditions.....	53
Section 2 - Automatic Overrides of Chilled Water Reset.....	53
Section 3 - Manual Overrides of Chilled Water Reset - and other Settings .....	54
Condenser Water Temperature Optimizer Reset .....	54
Section 1 - Condenser Water System Optimizer - Enable Conditions .....	55
Section 2 - Manual Overrides of Condenser Water Reset - and other Settings .....	55
Section 3 - Condenser Water Setpoint Reset - Output & Limit Settings .....	55
Electric Metering - Combined kW of Monitored Equipment.....	56
<b>Appendix B: The Chilled Water System Optimizer Commissioning view of the Properties page</b> .....	<b>58</b>
General Conditions & Status.....	59
Section 1 - Optimizer - Primary Enable Conditions.....	60
Section 2 - Chiller System Power, Efficiency, and Thermal Load Input Status .....	63
Section 3 - Stagger Reset - Enable Conditions.....	65
Section 4 - Optimizer Setpoint Change Mode .....	66
Chilled Water Temperature Optimizer Reset .....	68
Section 1 - Chilled Water System Optimizer - Enable conditions.....	69
Section 2 - Automatic Overrides of Chilled Water Reset.....	70
Section 3 - Manual Overrides of Chilled Water Reset - and other Settings .....	75
Condenser Water Temperature Optimizer Reset .....	80
Section 1 - Condenser Water System Optimizer - Enable Conditions .....	82
Section 2 - Manual Overrides of Condenser Water Reset - and other Settings .....	83
Section 3 - Condenser Water Setpoint Reset - Output & Limit Settings .....	87
Electric Metering - Combined kW of Monitored Equipment.....	89
<b>Appendix C: Network Points List for Chilled Water System Optimizer</b> .....	<b>91</b>
<b>Document revision history</b> .....	<b>93</b>

## What is the Chilled Water System Optimizer?

The Chilled Water System Optimizer (Part# OPN-OPT-OL) provides precise chilled water and condenser water setpoint optimization by carefully balancing the energy use of both the chilled water plant equipment and the chilled water consumers. This results in an overall reduction in energy use and electrical demand.

You can select from the following protocols:

- BACnet/IP
- Modbus RTU or ASCII
- Modbus/IP

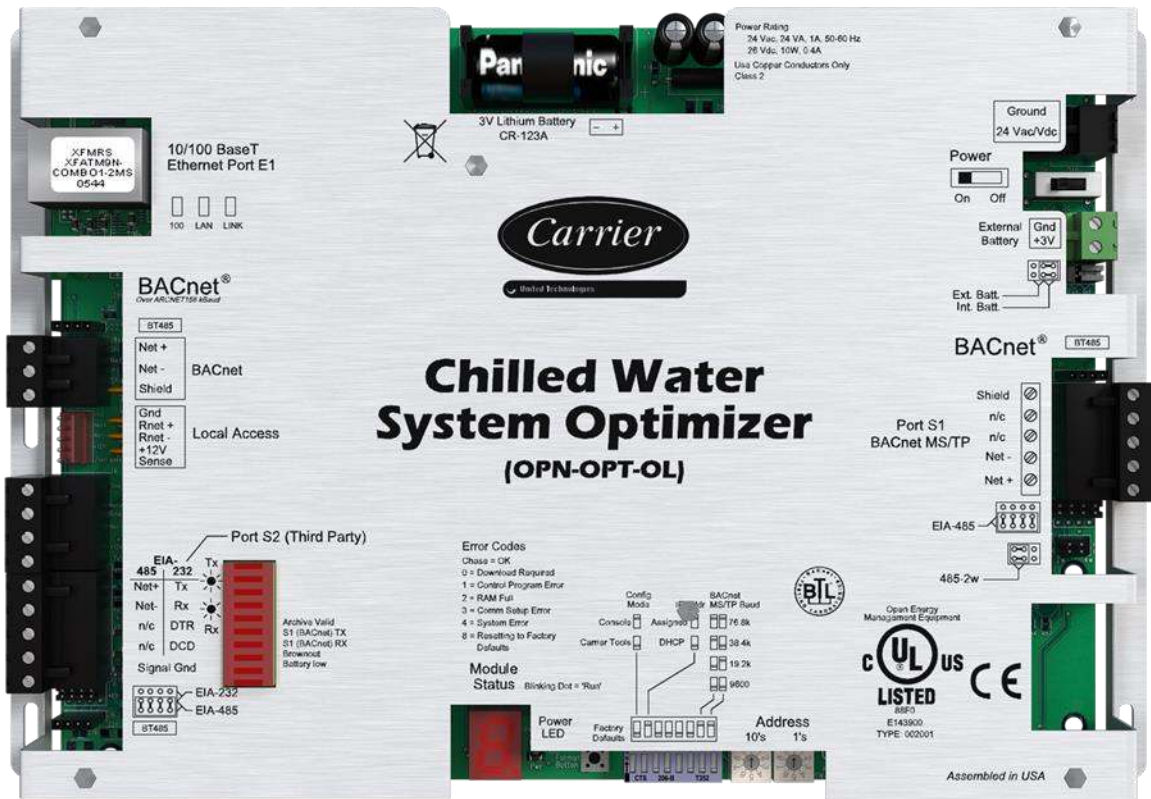

**⚠ CAUTION** The Chilled Water System Optimizer does not support BACnet MS/TP or BACnet/ARC156 networks.



**⚠ WARNING** The Chilled Water System Optimizer must not be used as a router. This function is not supported.

## Specifications

---

Driver	drv_opn_opt_std
Number of control programs	 <b>WARNING</b> This controller only supports a single Chilled Water System Optimizer program and no other control programs.
Power	24 Vac $\pm$ 10%, 50–60 Hz 24 VA power consumption 26 Vdc (25 V min, 30 V max) Single Class 2 source only, 100 VA or less
Port E1 (10/100 BaseT Ethernet)	For Ethernet LAN, BACnet IP, and Modbus TCP/IP communication at 10 or 100 Mbps, half duplex  Both <b>Assigned</b> (default) and <b>DHCP</b> IP addressing are supported and DIP switch selectable
Port S1 (BACnet MS/TP)	Not supported - do not use.
BACnet port (ARCNET)	Not supported - do not use.
Port S2	Configurable EIA-485/EIA-232 port for Modbus (RTU and ASCII modes) - 9600 bps, 19.2 kbps, 38.4 kbps
Local Access	For system start-up and troubleshooting
Real time clock	Battery-backed real-time clock keeps track of time in event of power failure
Battery	10-year Lithium CR123A battery ensures the following data is retained for a maximum of 720 hours during power outages: <ul style="list-style-type: none"> <li>• Time</li> <li>• Graphics</li> <li>• Control programs</li> <li>• Editable properties</li> <li>• Schedules</li> <li>• Trends</li> </ul> <p>To conserve battery life, you can set the driver to turn off battery backup after a specified number of days and depend on the archive function to restore data when the power returns. A low battery is indicated by the <b>Battery Low</b> LED or a low battery alarm in the i-Vu® application, a touchscreen device, and Field Assistant.</p>
Protection	Built-in surge and transient protection for power and communications in compliance with EN61000-6-1.  Incoming power and network connections are protected by non-replaceable internal solid-state polyswitches that reset themselves when the condition that causes a fault returns to normal.  The power and network connections are also protected against transient excess voltage/surge events lasting no more than 10 msec.   <b>CAUTION</b> To protect against large electrical surges on serial EIA-485 networks, place a PROT485 at each place wire enters or exits the building.



Status indicators	LED status indicators for <b>Port S1</b> and <b>S2</b> communication, <b>Ethernet Port E1</b> communication, and low battery status. Seven segment status display for running, error, power status, archive valid, and brownout.
Environmental operating range	-20 to 140°F (-29 to 60°C), 10–90% relative humidity, non-condensing
Storage temperature range	-24 to 140°F (-30 to 60°C), 0 to 90% relative humidity, non-condensing
Physical	Rugged aluminum cover, removable screw-type terminal blocks

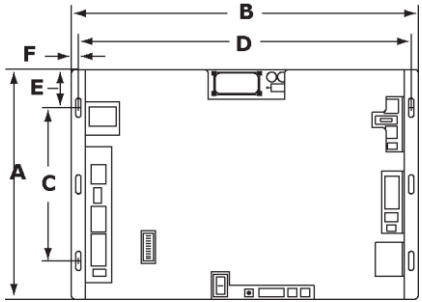

Overall dimensions	A:	7-1/2 in. (19.1 cm)
	B:	11-5/16 in. (28.7 cm)
Mounting dimensions	C:	5 in. (12.7 cm)
	D:	10-7/8 in. (27.6 cm)
	E:	1-1/4 in. (3.2 cm)
	F:	1/4 in. (.6 cm)
Mount with 6-32 by 1/2 in. mounting screws		
Depth	1-1/4 in. (3.2 cm)	
Weight	1.4 lbs (0.64 kg)	
BACnet support	Conforms to the BACnet Building Controller (B-BC) Standard Device Profile as defined in ANSI/ASHRAE Standard 135-2012 (BACnet) Annex L, Protocol Revision 9	
Listed by	UL916 (Canadian Std C22.2 No. 205-M1983, CE, FCC Part 15 - Subpart B - Class A	

## Chiller system configurations

The program is scalable, so it can be applied from a minimal system including only the chiller and chilled water pump components, to a larger system, including condenser water side components and air handling unit fans, as illustrated below.

What is the Chilled Water System Optimizer?

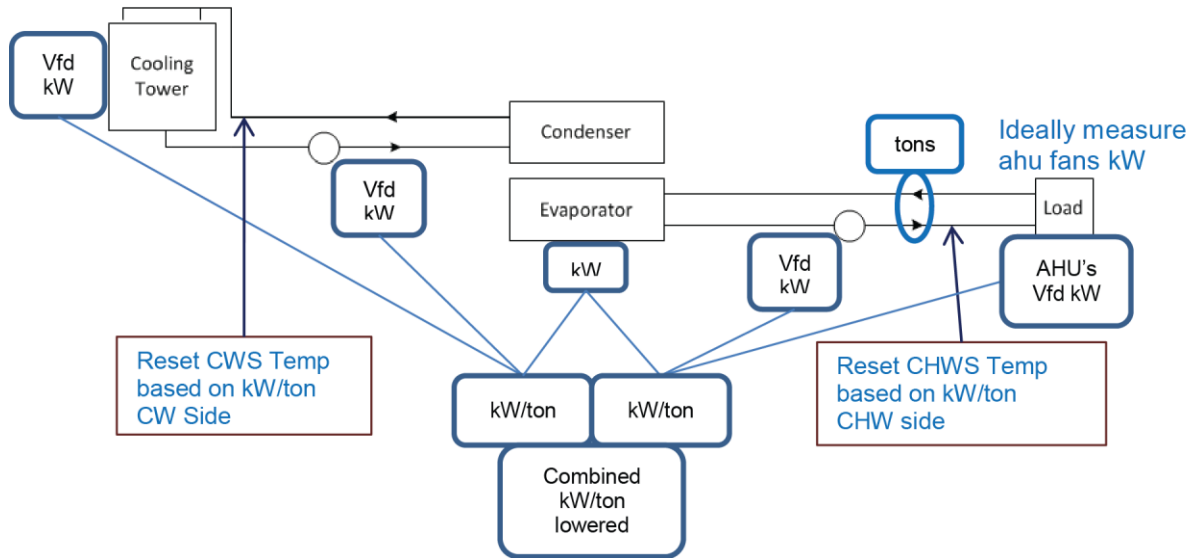

Even though the controller works with a variety of chilled water system components, it must be used with parallel chiller systems and operates best with variable speed pumps and variable speed fans.

The Chilled Water System Optimizer works with systems containing any of the following:

- Single chiller or multiple chillers piped in parallel
- Chilled water pumps
- Cooling towers
- Condenser water pumps
- Variable speed air handling unit fans (w/ chilled water coils)
- Chilled water side – when secondary pumps and tertiary pumps are part of the chilled water system, including variable air handling unit fans.
- Condenser water side – systems with multiple cooling towers and condenser water pumps dedicated to their corresponding chiller, or piped in parallel.

### CAUTIONS

- The control program can be less effective if the setpoint response is not predictable. For example, when the cooling towers are widely staged to come on above certain temperature thresholds, rather than using modulating VFD fans or pumps for capacity control.
- The Chilled Water System Optimizer is not designed for series arrangements or absorption chillers.

The Chilled Water System Optimizer can be applied to the following chiller system designs:

- **Chilled water supply side**
  - Up to 8 chillers piped in parallel arrangement
    - Centrifugal, scroll type, or screw type chillers

- Equal-sized or unequal-sized
- Up to 40 primary, secondary, and/or tertiary variable speed pumps
- Up to 40 variable speed air handling unit fans serviced by chilled water system
- **Condenser water supply side**
  - Up to 20 condenser water pumps
  - Up to 20 cooling tower variable speed or staged fans

## Installation overview

---



**WARNING** This controller only supports a single Chilled Water System Optimizer program and no other control programs.

The Chilled Water System Optimizer collects remote power (kW) values and facility thermal load values residing in other controllers through Network Input points.

The program functions most efficiently and provides increased energy savings if all pumps and fans have variable frequency drives and as more power inputs are measured, though it is not necessary.

### Control Inputs

- Power Inputs – Sum of power inputs  $\Sigma$  kW
  - Chiller power kW (required)
  - Chilled Water Pump kW (required)
  - Cooling Tower Fan kW (optional)
  - Condenser Water Pump kW (optional)
  - Air Handling Unit Fan kW (desirable but not absolutely necessary)
- Load Input – Total Cooling Load

**NOTE** This is thermal cooling load in tons, whether calculated from the difference between chilled water supply and return temperatures and the flow rate, or tonnage that is read directly.
- Result – kW/Ton (Dividing total kW by the thermal load equals the efficiency benchmark of kW/ton)

### Control Outputs – Network Outputs

The optimization program has only two control outputs. They are either Network Outputs or BACnet Analog Values.

- Chilled water supply temperature reset
- Condenser water supply temperature setpoint

## Safety considerations

---

 **WARNING** Disconnect electrical power to the controller before wiring it. Failure to follow this warning could cause electrical shock, personal injury, or damage to the controller.

## Installing the Chilled Water System Optimizer

Follow these steps:

- 1 *Mount the controller.* (page 7)
- 2 *Wire the controller for power.* (page 7)
- 3 *Set the controller's address.* (page 18, page 9)
- 4 *Communicate through the Local Access port.* (page 18)
- 5 *Wire for communications.* (page 13)
- 6 *Add the controller to the i-Vu® application.* (page 21)
- 7 *Set up driver.* (page 23)

### To mount the controller

---

#### **WARNING**

When you handle the Chilled Water System Optimizer:

- Do not contaminate the printed circuit board with fingerprints, moisture, or any foreign material.
- Do not touch components or leads.
- Handle the board by its edges.
- Isolate from high voltage or electrostatic discharge.
- Ensure that you are properly grounded.

Screw the controller into an enclosed panel using the mounting slots on the cover plate. Leave about 2 in. (5 cm) on each side of the controller for wiring. See mounting dimensions in *Specifications* (page 2).

### Wiring the controller for power

---

 **WARNING** Do not apply line voltage (mains voltage) to the controller's ports and terminals.

#### **CAUTIONS**

- The controller is powered by a Class 2 power source. Take appropriate isolation measures when mounting it in a control panel where non-Class 2 circuits are present.
- Carrier controllers can share a power supply as long as you:
  - Maintain the same polarity.
  - Use the power supply only for Carrier controllers.



## To wire for power

- 1 Make sure the controller's power switch is in the **OFF** position to prevent it from powering up before you can verify the correct voltage.
- 2 Remove power from the power supply.
- 3 Pull the screw terminal connector from the router's power terminals labeled **24 Vac/Vdc** and **Ground**.
- 4 Connect the transformer wires to the screw terminal connector.
- 5 Apply power to the power supply.
- 6 Measure the voltage at the controller's power input terminals to verify that the voltage is within the operating range of 21.6 – 26.4 Vac or 23.4 - 28.6 Vdc.
- 7 Insert the screw terminal connector into the controller's power terminals.
- 8 Turn **on** the controller's power.
- 9 Verify that the Run LED (a dot in the lower right corner of the **Module Status** LED) begins blinking. The **Module Status** LED will display **8** for about 5 seconds and then reverts to **0**, until controllers have been found and downloaded. There is a chase pattern when the router is running with no errors.

## Addressing the controller

To address the controller for third-party integration, in the i-Vu® interface, go to **Driver Properties > Protocols > Properties** tab. Refer to the appropriate protocol *Integration Guide* for further details.

The controller needs...	That is unique on the...	Notes
An IP address	IP Network	<p>Set the <b>IP Addr</b> DIP switch to choose one of the following:</p> <ul style="list-style-type: none"> <li>• <b>DHCP</b> — to obtain an IP address from a DHCP server If there is no DHCP server, the following are the default IP settings: <ul style="list-style-type: none"> <li>○ 192.168.168.xx, where xx = rotary address</li> <li>○ subnet mask = 255.255.255.0</li> <li>○ default gateway = 192.168.168.254</li> </ul> </li> <li>• <b>Assigned</b> — a <b>custom</b> IP address</li> </ul> <p><b>NOTE</b> The controller address is also used to autogenerate the BACnet device instance/name for the router. See Configuring BACnet device instance and network number.</p>

## To set the controller address on the Open network



**CAUTION** The controller address must be unique on the IP and Open network.

- 1 If wired for power, turn off the power.

**NOTE** The controller only reads the rotary switch positions during power up or upon reset.

- 2 Use the rotary switches to set the address. Set the **Tens (10's)** switch to the tens digit of the address, and set the **Ones (1's)** switch to the ones digit. Valid addresses are 1 - 99.

**EXAMPLE** If the controller's address is 25, point the arrow on the **Tens (10's)** switch to 2 and the arrow on the **Ones (1's)** switch to 5.

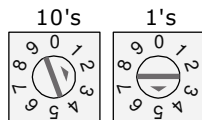

- 3 Turn on the controller's power.



**CAUTION** The factory default setting is **00** and must be changed to successfully install your controller.

## To choose an IP addressing scheme

---

Carefully plan your addressing scheme to avoid duplicate IP addresses.

- If there is a DHCP server on the network, and, if you have a single controller or multiple controllers that exist on the SAME subnet, use DHCP addressing. Skip to the section *To obtain an IP address using DHCP* (page 10).
- If you have multiple controllers that reside on different subnets, you cannot use DHCP addressing. Instead, give each controller an assigned IP address. Skip to the section *To assign a custom IP address* (page 10).

**NOTE** This network configuration also requires that you configure IP Broadcast Management Devices (BBMDs). See *To set up BACnet Broadcast Management Devices*.

## To obtain an IP address using DHCP

---

- 1 Turn the controller's power off.
- 2 Set the **IP Addr** DIP switch **DHCP** to **On**.
- 3 Turn the controller's power on. The DHCP server assigns an IP address to the controller.



**CAUTION** If the DHCP server is not found, the following default IP address settings will be used:

- IP address = 192.168.168.xx, where xx = controller address (rotary switch settings)
- Subnet Mask = 255.255.255.0
- Default Gateway = 192.168.168.254

## To assign a custom IP address

---

- 1 Obtain the IP address, subnet mask, and default gateway address for the router from the facility network administrator.
- 2 Turn the controller's power off.
- 3 Set the controller's **IP Addr** DIP switch **Assigned** to **On**.
- 4 Configure the controller by setting the **Router Config Mode** DIP switch **Console** to **On** using a terminal program such as PuTTY or Hyperterminal.
- 5 Turn the controller's power on.

## PREREQUISITES

- A computer with a USB port
- A USB Link cable — See *To communicate through the Local Access port with a USB Link* (page 18)



**CAUTION** If multiple controllers share power but polarity was not maintained when they were wired, the difference between the controller's ground and the computer's AC power ground could damage the USB Link and the controller. If you are not sure of the wiring polarity, use a USB isolator between the computer and the USB Link. Purchase a USB isolator online from a third-party manufacturer.

## Using PuTTY

- 1 Download and install PuTTY from the *PuTTY website* (<http://www.chiark.greenend.org.uk/~sgtatham/putty/download.html>).
- 2 Connect the laptop to the local access port of the router, ZS sensor, or an SPT sensor using the USB Link cable(s).

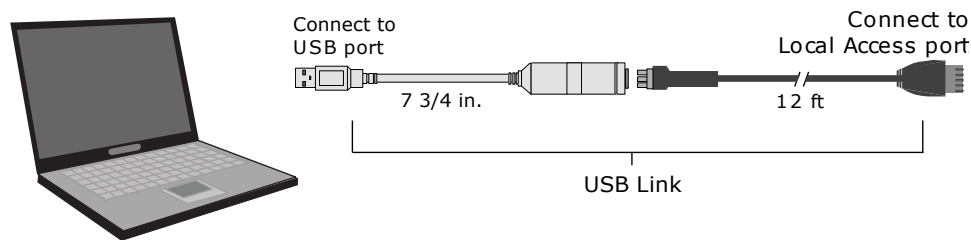

**NOTE** If using a USB isolator, plug the isolator into your computer's USB port, and then plug the USB Link cable into the isolator.

- 3 To change a router's IP address, subnet mask, or default gateway, set its **IP Address** DIP switch to **Assigned**.
- 4 Start PuTTY.
- 5 Under **Category > Connection**, select **Serial**.
- 6 Under **Options controlling local serial lines**, enter the following settings:

Field	Value
<b>Serial line to connect to</b>	Replace X with the computer's port number that the USB Link cable is connected to.  <b>NOTE</b> To find the port number, select <b>Start &gt; Control Panel &gt; System &gt; Device Manager &gt; Ports (Com &amp; LPT)</b> . The COM port number is beside <b>Silicon Labs CP210x USB to UART Bridge</b> .
<b>Speed (baud)</b>	115200
<b>Data Bits</b>	8
<b>Stop Bits</b>	1

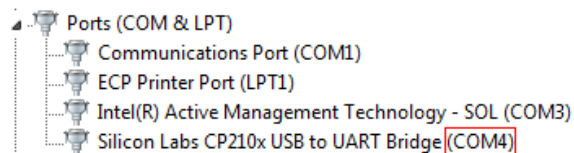

<b>Parity</b>	None
<b>Flow Control</b>	None

7 Click **Open**. A window similar to the one below appears.

```
1) Restart
2) Display Modstat
3) IP Address [192.168.1.6]
4) Subnet Mask [255.255.255.0]
5) Default Gateway [0.0.0.0]
```

8 Do one of the following:

- o To change a property value:
  - a. Type the number of the property, then press **Enter**.
  - b. Type the new value, then press **Enter**.
- o To take an action, type number of the action, then press **Enter**.

9 If you changed a value, type 1, then press **Enter** to restart the controller.

10 Close PuTTY.

11 Verify that you can communicate with the controller by issuing a PING command to the IP address specified in step 12.

**NOTE** Your computer must be on the same subnet as the controller for the PING command to work.

12 When finished, set the controller's **Router Config Mode** DIP switch to **OFF** to restore normal functionality to the Local Access port.

13 Cycle the controller's power to accept the **Router Config Mode** changes.



## Wiring for communications

The controller has multiple ports. See table below for port descriptions.

Port	Protocol	Port type(s)	Baud rate(s)	Use for
<b>Ethernet Port E1</b>	BACnet/IP Modbus/IP	Ethernet	10 Mbps 100 Mbps	LAN connection
	<b>NOTE</b> Both protocols can run simultaneously			
<b>S2*</b>	Modbus	EIA-485	9600, 19.2k, or 38.4k bps	Third-party communication
<b>Local Access</b>	Enhanced Access	Rnet	115.2 kbps	<ul style="list-style-type: none"> <li>• Configuration</li> <li>• System start-up and troubleshooting</li> </ul>

\* The **Config Mode** DIP switch **Console** must be **Off** (down position) to use Port S2. Port S2 supports only one protocol and one wire type at a time.



**CAUTION** The Chilled Water System Optimizer does not support BACnet MS/TP or BACnet ARCNET networks.

## Ethernet wiring specifications

For...	Use...	Maximum Length
Ethernet	CAT5e or higher Ethernet cable	328 feet (100 meters)

\*For details see the *Open Controller Network Wiring Guide*.



**WARNING** Do not apply line voltage (mains voltage) to the controller's ports and terminals.

## To wire to the BACnet over IP network (DHCP)

---

- 1 Turn **off** the controller's power.
- 2 Check the communications wiring for shorts and grounds.
- 3 Set the **Assigned/DHCP** DIP switch to the **DHCP** position.
- 4 Verify DIP switch **1** is set to **Carrier Tools (Off)**.
- 5 Connect Port E1, which is the only port that speaks BACnet over IP.
- 6 Turn **on** the controller's power.

## To wire to a BACnet over IP network (assign a custom IP)

---

- 1 Turn **off** the controller's power.
- 2 Using the rotary switches, set the controller's address. Set the Tens (10's) switch to the tens digit of the address, and set the **Ones (1's)** switch to the ones digit.

**EXAMPLE** If the controller's address is 25, point the arrow on the **Tens (10's)** switch to 2 and the arrow on the **Ones (1's)** switch to 5.

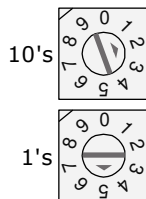

- 3 Obtain the IP address, subnet mask, and default gateway address for the controller from the facility network administrator.
- 4 Set the **Assigned/DHCP** DIP switch to the **Assigned** position.
- 5 Set the **+100/0** DIP switch to **On** to add 100 to **x** in the IP address.  
**EXAMPLE** If you turn on this DIP switch and the MAC address is 25, the IP address is 192.168.168.125.  
**NOTE** The DHCP address is an intranet address. Data packets from this address are not routable to the Internet.
- 6 Set the following using a touchscreen device or PuTTY.
  - o IP address
  - o A unique Device Instance number

- 7 Connect Port E1, which is the only port that speaks BACnet over IP.

**Wiring Specifications**

- 328 feet (100 meters)
- Use one of the following CAT5 or higher Ethernet cables:
  - A cross-over cable to connect the controller directly to the third-party device
  - A straight-through cable to connect the controller to a hub or switch, and a second straight-through cable to connect the hub or switch to the third-party device

**NOTE** Use the same polarity throughout the network segment.

- 8 Turn **on** the controller's power.

## Wiring for third party protocols

You can connect third party protocols after you set up BACnet. The driver for the controller allows access to the following third party protocols. Additional drivers are not required.

You can use this combination of protocols or a subset of them:

Port	Protocol(s)
Port S2	Modbus RTU or ASCII, master or slave
Port E1	All or any combination of the following: <ul style="list-style-type: none"> <li>• BACnet/IP</li> <li>• Modbus/IP</li> </ul>

### To wire Modbus devices on Port S2

- 1 Turn off the controller's power.
- 2 Check the communications wiring for shorts and grounds.
- 3 Set the **Router Config Mode** DIP switch **Console** to **Off** (down position).
- 4 Wire the controller's Port S2 to the third-party device, then set the S2 jumper. See table and notes below.
- 5 Turn on the controller's power.

For...	Use controller port...	Wire Carrier terminal...	...to third-party device terminal	Set the port's jumper(s) on controller
EIA-232	S2	TX Rx Signal Ground	Rx Tx Gnd	EIA-232
EIA-485, 2-wire	S2	Net+ Net-	+ -	EIA-485 2-wire

#### NOTES

- If you cannot determine the media type or connections of the third-party device, contact your third-party representative.
- Use the same polarity throughout the network segment.
- Repeaters are required for more than 31 devices. See your third-party device manufacturer's recommendations.

- To reduce communication and data errors, terminate each end of an EIA-485 network with a resistor whose value equals the network's characteristic impedance. Some third-party manufacturers provide a built-in resistor that you enable or disable with a jumper. Make sure that only devices at the end of a network have termination enabled.

**EXAMPLE** If an EIA-485 2-wire network's characteristic impedance is 120 Ohms, terminate one pair by placing a 120 Ohm resistor across the **Net+** and **NET-** connectors of the controller. Terminate the other pair by placing a 120 Ohm resistor across the **+** and **-** connectors of the furthest third-party controller.

- A solid receive light on the controller indicates a wiring or polarity problem.

## To wire a third-party device

---

See the *Integration Guide* for the third-party device or protocol.



## Communicating through the Local Access port with a USB Link

Using a computer and a USB Link, you can communicate locally with the controller to download or to troubleshoot.



### CAUTIONS

- Maintain polarity when controllers share power.
- Failure to maintain polarity while using the USB Link on a computer that is grounded via its AC adapter may damage the USB Link and the controller.
- If multiple controllers share power but polarity was not maintained when they were wired, the difference between the controller's ground and the computer's AC power ground could damage the USB Link and the controller. If you are not sure of the wiring polarity, use a USB isolator between the computer and the USB Link. Purchase a USB isolator online from a third-party manufacturer. Plug the isolator into your computer's USB port, and then plug the USB Link cable into the isolator.

### PREREQUISITES

- For the i-Vu® application to communicate with the controller, the controller must have been downloaded with at least its driver.
- Laptop with USB port
- USB Link (Part #USB-L)

### Using a USB Link

- 1 The USB Link driver is installed with an i-Vu® v5 or later system. But if needed, you can get the latest driver from <http://www.silabs.com/products/mcu/Pages/USBtoUARTBridgeVCPDrivers.aspx>. Install the driver before you connect the USB Link to your computer.
- 2 Connect the laptop to the controller or sensor using the appropriate USB Link cable(s).

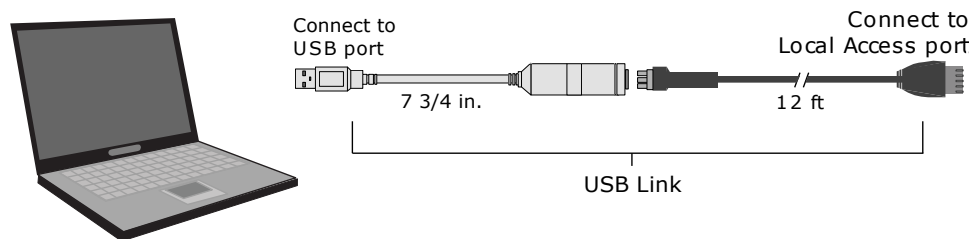

**NOTE** If using a USB isolator, plug the isolator into your computer's USB port, and then plug the USB Link cable into the isolator.

- 3 Set the controller's **Router Config Mode** DIP switch.

To communicate in...	Set switch to...
The i-Vu® application	Off
PuTTY	On

**NOTE** See *To communicating using PuTTY* (page 19)

- 4 Turn the controller's power off, then on again.

## To communicate using PuTTY

You can connect a computer to a controller's Local Access port and use PuTTY, a free open source terminal emulation program, to:

- Set the baud rate for Port S1 on the controller
- Set controller properties, such as IP address and network information
- Retrieve a Modstat

### PREREQUISITES

- A computer with a USB port
- A USB Link cable
 

**NOTE** The USB Link driver is installed with an i-Vu® v5 or later system. But if needed, you can get the latest driver from <http://www.silabs.com/products/mcu/Pages/USBtoUARTBridgeVCPDrivers.aspx>. Install the driver before you connect the USB Link to your computer.



**CAUTION** If multiple controllers share power but polarity was not maintained when they were wired, the difference between the controller's ground and the computer's AC power ground could damage the USB Link and the controller. If you are not sure of the wiring polarity, use a USB isolator between the computer and the USB Link. Purchase a USB isolator online from a third-party manufacturer.

### Using PuTTY

- 1 Download and install PuTTY from the *PuTTY website* (<http://www.chiark.greenend.org.uk/~sgtatham/putty/download.html>).
- 2 Connect the laptop to the controller or sensor using the appropriate USB Link cable(s), as described above.
- 3 To change a router's IP address, subnet mask, or default gateway, set its **IP Address** DIP switch to **Assigned**.
- 4 Start PuTTY.
- 5 Under **Category > Connection**, select **Serial**.

6 Under **Options controlling local serial lines**, enter the following settings:

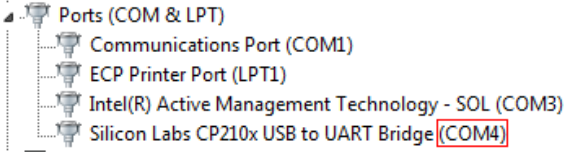
Field	Value
<b>Serial line to connect to</b>	<p>Replace X with the computer's port number that the USB Link cable is connected to.</p> <p><b>NOTE</b> To find the port number, select <b>Start &gt; Control Panel &gt; System &gt; Device Manager &gt; Ports (Com &amp; LPT)</b>. The COM port number is beside <b>Silicon Labs CP210x USB to UART Bridge</b>.</p> 
<b>Speed (baud)</b>	115200
<b>Data Bits</b>	8
<b>Stop Bits</b>	1
<b>Parity</b>	None
<b>Flow Control</b>	None

7 Click **Open**. A window similar to the one below appears.

```

1) Restart
2) Display Modstat
3) IP Address [192.168.1.6]
4) Subnet Mask [255.255.255.0]
5) Default Gateway [0.0.0.0]
    
```

8 Do one of the following:

- o To change a property value:
  - a. Type the number of the property, then press **Enter**.
  - b. Type the new value, then press **Enter**.
- o To take an action, type number of the action, then press **Enter**.

9 If you changed a value, type 1, then press **Enter** to restart the controller.

10 Close PuTTY.

## Installing the controller into an i-Vu® Control System

You must complete the following procedures to successfully install your controller into an i-Vu® Control System. Use the Help in the referenced software for detailed descriptions of these procedures.

### EquipmentBuilder

- 1 Use EquipmentBuilder to create the control program for your controller.
- 2 If applicable, print the Sequence of Operation.

### The i-Vu® or Field Assistant application

- 1 In the i-Vu® or Field Assistant interface, select the system level in the navigation tree.
- 2 On the **Devices** page > **Manage** tab, click **Find Devices**.
- 3 Select the controller in the list and click **Upload**. Wait until this is completed.
- 4 Click **Add Control Program**. A dialog window appears.
- 5 Enter a name for your control program in **Display Name** and select the controller in the **Controller** drop-down list.

**NOTES** You can change the control program's **Reference Name** if needed.

- 6 Do one of the following:

If the control program is...	
In the <b>Control Program</b> drop-down list	Select the control program.
Not in the <b>Control Program</b> drop-down list	<ol style="list-style-type: none"> <li>a. Click <b>Add New</b>.</li> <li>b. Browse to select the control program.</li> <li>c. Click <b>Open</b>.</li> <li>d. Click <b>Continue</b>.</li> <li>e. Click Close.</li> </ol>

- 7 To upload the graphic, click **Add New** under **Views** and browse to your .view file.
- 8 Click **Continue**. When message appears **File added successfully**, click **Close**.
- 9 Click **Close** again.
- 10 Right-click on the programmable controller in the controller list and select **Check Status** from the list. The status of the controller should say **File Mismatch**.
- 11 Click the **Download All Content** button.
- 12 Configure the controller on the **Properties** page > **Control Program** tab.
- 13 Check out and commission the equipment.

## To configure third party protocols in the i-Vu® interface

---

After you download the driver and control program to the controller, you must configure the protocol properties in the i-Vu® interface.

### Modbus RTU on Port S2

- 1 Verify the **Port S2** DIP switch (5) **TPI** is **On** and the controller's power has been cycled.
- 2 In the i-Vu® navigation tree, right-click the controller and select **Driver Properties** from the drop-down menu.
- 3 Under **Driver**, expand **Protocols**, then select **Modbus**.
- 4 Under **Port Configuration**, check **Enable** under **Port S2**.
- 5 Select **EIA-485** for **Communication Type**.
- 6 Enter your **Baud** rate.
- 7 Under **Protocol Configuration**, select the correct option for **Is this device a Master?**
- 8 Accept all other default settings.
- 9 Click **Accept**.

**NOTE** You can configure the controller for either Modbus RTU or Modbus IP, not both at the same time.

### Modbus over IP network

- 1 Verify the **Port S2** DIP switch (5) **TPI** is **On** and the controller's power has been cycled.
- 2 Turn the controller off and then on again.
- 3 In the i-Vu® navigation tree, right-click the controller and select **Driver Properties** from the drop-down menu.
- 4 Under **Driver**, expand **Protocols > Modbus TCP/IP**.
- 5 Select **TCP/IP** for **Communication Type**.
- 6 Under **Modbus Protocol Configuration**:
  - o If your controller is a client:
    1. Select **Yes** for **This device is a Client**.
    2. Click **Accept**.
    3. In the navigation tree, under **Protocols > Modbus TCP/IP**, go to **IP Index Table** and follow the directions at the bottom of the page to fill in the **Server IP Addresses**.
  - o If your controller is a server, select **No** for **This device is a Client**.
- 7 Accept all other default settings.
- 8 Click **Accept**.

**NOTE** You can configure the controller for either Modbus RTU or Modbus IP, not both at the same time.

## To set up the driver

After you download the driver and control program to the controller, you may want to change the driver's properties in the i-Vu® interface to suit your application.

- 1 In the i-Vu® navigation tree, right-click the controller and click **Driver Properties** from the drop-down menu.
- 2 Make changes as needed on the **Properties** page for **Driver**.

## Driver

On the **Driver** page, you can change the following properties:

- Backup battery conservation settings. See table below.
- Module clock synchronization and failure. See table below.
- Network Input microblock communication properties.

### Backup Battery

**Turn off Internal backup battery after \_\_\_ days to conserve battery life (shutoff date/time)**

How long backup battery should run after power loss.



**TIP** Downloading activates the battery backup. To conserve battery life when you know the controller will be without power for an extended period after downloading (for example, during shipment):

- 1 Verify the **Archive Valid** LED is lit, then set this field to 0.
- 2 After you install the controller and apply power, enter a number greater than 0.

### TouchScreen Control

**TouchScreen Schedule Edit Enable**

Check this field to allow a user to edit this controller's schedules from an Equipment Touch or System Touch Schedules screen.

**NOTE** Schedules edited on an Equipment Touch or System Touch are not uploaded to the i-Vu® application. This could result in the controller operating on a schedule that differs from the one you see in the i-Vu® interface.

### Module Clock

**Clock Fail Date and Time**

Date and time the control program uses when controller's real-time clock is invalid.



**TIP** Use an occupied date and time (such as a Tuesday at 10 a.m.) so the equipment does not operate in unoccupied mode if the controller loses power during occupancy.

**Time Synch Sensitivity (seconds)**

When the controller receives a time sync request, if the difference between the controller's time and the time sync's time is greater than this field's value, the controller's time is immediately changed. If the difference is less than this field's value, the controller's time is slowly adjusted until the time is correct.

### Network Microblocks

<b>Number of poll retries before Network Input Microblocks indicate failure</b>	The maximum number of retries after the initial attempt that a Network microblock will attempt to communicate with its target device. If unsuccessful, the point will transition to an idle state for 30 seconds before attempting to communicate again. Change this field only if directed by Technical Support.
<b>Periodic rebinding Interval</b>	If a microblock uses a wildcard in its address, this timer determines how often the microblock will attempt to find the nearest instance of its target. For example, if an outside air temperature address uses a wildcard, a VAV application will look for the outside air temperature on the same network segment or on the nearest device containing that object.
<b>BACnet COV Throttling</b>	
<b>Enable COV Throttling</b>	<p>Under normal circumstances, COV Throttling should be enabled to prevent excessive network traffic if an object's COV Increment is set too low. See EXCEPTION below.</p> <p>When enabled, if an object generates excessive COV broadcasts (5 updates in 3 seconds), the driver automatically throttles the broadcasts to 1 per second. Also, if the object's value updates excessively for 30 seconds, an alarm is sent to the i-Vu® application listing <u>all</u> objects that are updating excessively. A Return-to-normal alarm is sent only after <u>all</u> objects have stopped updating excessively.</p> <p>EXCEPTION: In rare circumstances, such as process control, a subscribing object may require COV updates more frequently than once per second. For these situations, clear this checkbox, but make sure that your network can support the increased traffic. You will also need to disable the <b>Excessive COV</b> alarms under the driver's <b>Common Alarms</b>.</p>
<b>Trend Sampling</b>	
<b>Collect a daily midnight sample for all points in this controller that are sampling on COV</b>	For values that change infrequently, select to verify at midnight daily that the point is still able to communicate trend values.

## Notification Classes

Alarms in the i-Vu® application use Notification Class #1. A BACnet alarm's Notification Class defines:

- Alarm priority for Alarm, Fault, and Return to Normal states
- Options for BACnet alarm acknowledgment
- Where alarms should be sent (recipients)

<b>Priorities</b>	<b>NOTE</b> BACnet defines the following Network message priorities for Alarms and Events.	
	<b>Priority range</b>	<b>Network message priority</b>
	00–63	Life Safety
	64–127	Critical Equipment
	128–191	Urgent
	192–255	Normal

<b>Priority of Off-Normal</b>	BACnet priority for Alarms.
<b>Priority of Fault</b>	BACnet priority for Fault messages.
<b>Priority of Normal</b>	BACnet priority for Return-to-normal messages.
<b>Ack Required for Off-Normal, Fault, and Normal</b>	Specifies whether alarms associated with this Notification Class require a BACnet Acknowledgment for Off-Normal, Fault, or Normal alarms.
	 <b>TIP</b> You can require operator acknowledgment for an Alarm or Return-to-normal message (stored in the i-Vu® database). In the i-Vu® interface on the <b>Alarm &gt; Enable/Disable</b> tab, change the acknowledgment settings for an alarm source or an alarm category.
<b>Recipient List</b>	
<b>Recipients</b>	The first row in this list is the i-Vu® application. Do not delete this row. Click <b>Add</b> if you want other BACnet devices to receive alarms associated with this Notification Class.
<b>Recipient Description</b>	Name that appears in the <b>Recipients</b> table.
<b>Recipient Type</b>	Use <b>Address</b> (static binding) for either of the following: <ul style="list-style-type: none"> <li>• Third-party BACnet device recipients that do not support dynamic binding</li> <li>• When you want alarms to be broadcast (you must uncheck <b>Issue Confirmed Notifications</b>). This use is rare.</li> </ul>
Days and times	The days and times during which the recipient will receive alarms.
<b>Recipient Device Object Identifier</b>	Type the <b>Device Instance</b> from the network administrator for third-party devices) in the # field.
<b>Process Identifier</b>	Change for third-party devices that use a BACnet Process Identifier other than 1. The i-Vu® application processes alarms for any 32-bit Process Identifier.
<b>Issue Confirmed Notifications</b>	Select to have a device continue sending an alarm message until it receives delivery confirmation from the recipient.
<b>Transitions to Send</b>	Uncheck the types of alarms you do not want the recipient to get.

## Calendars

Calendars are provided in the driver for BACnet compatibility only. Instead, use the **Schedules** feature in the i-Vu® interface.



To set up the driver

## Common and Specific Alarms

---

On these pages, you can enable/disable, change BACnet alarm properties, or set delays for the following BACnet alarms:

**Common alarms:**

- Module Halted
- All Programs Stopped
- Duplicate Address
- Locked I/O
- Control Program
- Program Stopped
- Excessive COV

**Specific alarm:**

- Dead Module Timeout
- Low Battery Alarm

**NOTE** To set up alarm actions for controller generated alarms, see "Setting up alarm actions" in i-Vu® Help.

Module Generated Alarm	
<b>Description</b>	Short message shown on the <b>Alarms</b> page or in an alarm action when this type of alarm is generated.
<b>Events</b>	
<b>Alarm Category and Alarm Template</b>	See "Alarms" in i-Vu® Help.
<b>Enable</b>	Clear these checkboxes to disable Alarm or Return to normal messages of this type from this controller.
<b>Notification Class</b>	Do not change this field.

## Custom Translation Tables

---

You can set up a translation table that an analog input will use to translate the raw data from a non-linear sensor to the engineering units you want it to provide on the output wire of the Analog Input microblock. In the navigation tree, select **Custom Translation Table #1, #2, or #3**. The **Properties** page has instructions. For the input to use the translation table, navigate to the input, select the **Details** tab, then set **Sensor Type (Scaling Method)** to **Non-Linear, Custom Table #\_\_**.

## BACnet firewall

---

Requires v6-02 or later driver

If this IP controller is accessible from the Internet, you can increase security by enabling its BACnet firewall. When enabled, this feature prevents the controller from responding to BACnet messages from unidentified sources and allows communication only with IP addresses that you define. These can be all private IP addresses and/or a list of IP addresses. Follow the instructions in the i-Vu® interface to set up the BACnet firewall.

## Protocols

---

On the **Protocols** page, you can enable or disable Telnet diagnostics. This allows you to write to a text file the communication between the controller and a third party device. This file is used for troubleshooting.

## Troubleshooting

If you have problems mounting, wiring, or addressing the controller or the Chilled Water System Optimizer, contact Carrier Control Systems Support.

**NOTE** To help you troubleshoot, obtain a Module Status (Modstat) from the controller and review the System Error and Warning details.

### Controller LED's

The **Module Status** LED can display the following error codes.

Error Code...	Indicates...	Possible solutions
0	The control program or driver has not been downloaded.	Download All Content to the controller.
1	A control program error	Obtain a Module Status Report (Modstat) and look for error conditions. See To get the controller's serial number below for instructions on obtaining a Modstat.  If you cannot determine the error from the Modstat, contact Carrier Control Systems Support.
2	The controller's memory is full	In the i-Vu® interface, reduce the amount of trend data being stored in the controller. In SiteBuilder, reduce the amount of control programs.
3	A setup error	Verify: <ul style="list-style-type: none"> <li>• The address has been set on the rotary switches. See Addressing the controller.</li> <li>• The address is unique on the network</li> <li>• DIP switches are set correctly</li> </ul>
4	A system error	Obtain a Module Status Report (Modstat) and look for error messages. See To get the controller's serial number below for instructions on obtaining a Modstat.  If you cannot determine the error from the Modstat, contact Carrier Control Systems Support.
8	Factory defaults are being restored	The number 8 should display only during the short restoring period. If this number displays continuously or flashes intermittently with another number, try each of the following: <ul style="list-style-type: none"> <li>• Turn the controller's power off, then on.</li> <li>• Format the controller. See <i>Restore factory defaults</i> (page 29) below.</li> <li>• Download the controller.</li> <li>• Replace the controller.</li> </ul>

Other LED's show the status of certain functions.

If this LED is on...	Status is...
<b>Power</b>	The controller has power..
<b>Link</b>	The controller is connected to the Ethernet.
<b>LAN</b>	The Ethernet port is transmitting or receiving data.
<b>100</b>	The connection speed is 100 Mbps. If LED is not lit, the connection speed is 10 Mbps.
<b>Archive Valid</b>	The controller's memory backup is valid.
<b>Port S1 transmit</b>	The controller is transmitting data from <b>Port S1</b> .
<b>Port S1 receive</b>	The controller is receiving data on <b>Port S1</b> .
<b>Battery low</b>	The battery is low.

## To restore factory defaults



**CAUTION** This erases all archived information and user-configuration settings. You will have to reconfigure all custom settings. It is recommended to restore the factory defaults only under the guidance of Carrier Control Systems Support.

To erase volatile memory data and restore factory default configuration settings:

- 1 Turn off the controller's power switch.
- 2 Make sure the address switches are not set to 0, 0.
- 3 Hold down the controller's **Factory Defaults** button while you turn its power on.
- 4 Continue to hold down the **Factory Defaults** button until the controller displays **8** and then the chase pattern, then release the button.
- 5 Turn on the controller's power switch.

## To get the serial number

---

If you need the controller's serial number when troubleshooting, the number is on:

- a sticker on the back of the main controller board
- a Module Status report (Modstat) under **Core** (or **Main**) **board hardware**

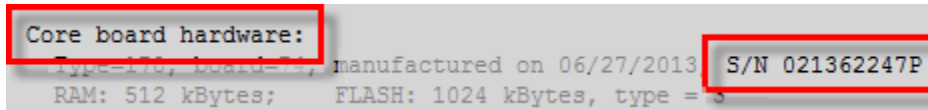

To obtain a modstat in the i-Vu® interface:

- 1 Select the controller in the navigation tree.
- 2 Right-click and select **Module Status**.

## To replace the controller's battery

---

The controller's 10-year Lithium CR123A battery retains the following data for a maximum of 720 hours during power outages: time, control programs, editable properties, schedules, and trends.

To conserve battery life, you can set the driver to turn off battery backup after a specified number of days and depend on the archive function to restore data when the power returns.

A low battery is indicated by the **Battery low** LED or a low battery alarm in the i-Vu® application. You can purchase replacement batteries from any retailer that sells a CR-123A battery.

- 1 Verify that the controller's power is on.
- 2 Using a small flathead screwdriver, pry up each side of the black battery clip until it is free and you can remove it.
- 3 Remove the battery from the controller, making note of the battery's polarity.
- 4 Insert the new battery into the controller, matching the polarity of the battery you removed.
- 5 Push the black clip back onto the battery until you hear both sides click in place.
- 6 Download the controller.

## To take the controller out of service

---

If needed for troubleshooting or start-up, you can prevent the i-Vu® application from communicating with the controller. When **Out of Service**, i-Vu® no longer communicates properties, colors, trends, etc..

- 1 On the i-Vu® navigation tree, select the controller.
- 2 On the **Properties** page, check **Out of Service**.
- 3 Click **Accept**.

## Start-up and Commissioning

The chilled water system optimization program gathers input values over the network, applies logic, and then outputs a chilled water temperature reset and a condenser water temperature setpoint. The new setpoints are designed to lower the chiller lift to save energy, while balancing it with increased energy consumed by the pumps and tower fans.

**NOTE** The program does not support any hardware points.

## Network Points

### Network Inputs

On the **Properties** page > **Network Points** tab:

- Verify that all input connections are linked, valid, and error-free.
- Set all remote inputs as **Network Visible**.
- Set all network input refresh times to low polling rates or to COV (change of value). If the response times are too slow, the program may lag in its calculations.
- We recommend you use kW instead of amperage whenever possible. If the equipment power is in amperage, use the appropriate formula based on voltage, phase, and power factor inputs.
- The links to each **Chiller ON** BNI2 should indicate the actual chiller status, from either the chiller manager or the chiller program, to determine when the chiller is actually running.

### Control Output – Chilled Water Supply Setpoint Value

- Link the Analog Network Input in the chiller program to the BACnet Analog Value Status in the optimization program.
- **NOTE** The chilled water supply setpoint signal is read and used by the chiller program. The Chilled Water Setpoint Value in the optimization program is exposed as a BACnet Analog Value Status.
- The chiller program, which is located in a separate controller, must retrieve the **Chilled Water Supply Setpoint Value** information. The program managing the chiller operation must verify the accuracy and integrity of the received chilled water supply setpoint value.
- Each chiller must have setpoint adjustment available, enabled, and working on each chiller.
- Obtain an approximation of the setpoint adjust response time by locking the optimization chilled water setpoint signal **Optimized Chilled Water Supply Setpoint AV**, under Chilled Water Temperature Optimizer Reset to a 40 to 50 °F reset value, and then verify response in the chiller manager program and each controlled chiller.
- Each operating chiller should recognize the signal and respond to find the new setpoint.
- You may need to tune the chiller program properties and chiller setpoint ramp rates to get proper response.

**NOTE** It is important that the chilled water setpoint be reset predictably and quickly enough for the optimizer to work reliably. Good response is essential and the actual response is subject to the system limits.

**Control Output – Condenser Water Supply Setpoint Signal**

- Link the Analog Network Input in the tower program to the BACnet Analog Value Status in the optimization program.

**NOTE** This is the condenser water supply setpoint signal that is read by the cooling tower program. The condenser water setpoint is exposed as a BACnet Analog Value Status.

- The tower program, in a separate controller, must retrieve the condenser water setpoint information. Verify accuracy of the condenser water setpoint signal.
- Obtain an approximation of the response time by locking the condenser water setpoint signal. See **Optimized Condenser Water Supply Setpoint AV (wetb + approach)**, under *Condenser Water Temperature Optimizer Reset* (page 80) to set a condenser water setpoint value, and then verify response in the tower manager program.
- You may need to tune PID properties and tower ramp rates.

**NOTE** It is important that the condenser water setpoint be reset predictably and quickly enough for the optimizer to work reliably. Good response is essential, though the actual response is still subject to the system and engineering judgment.

## General conditions and status

---

After you complete network point checkout, run a sequence checkout. The chiller plant must be on and running in mechanical mode. The chillers and chilled water pumps must be running in order to check out the chilled water optimization program.

After they have been running for a sufficient time to stabilize, expand **Properties > General Conditions & Status** and verify the following:

**Section 1 - Optimizer – Primary Enable Conditions** (page 60)

**1 Is the Main ON Switch Enabled?**

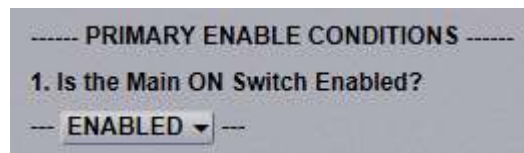

**2 Plant is ON** when the **0.1 Plant ON** binary network input is **On**, indicating chiller plant is running normally and the number of operating chillers is correctly detected.

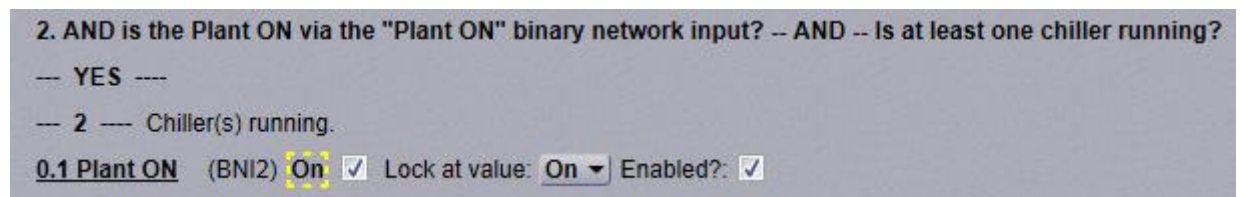

- 3 Optimization program is either scheduled or the **Schedule** present value is locked to **On**.

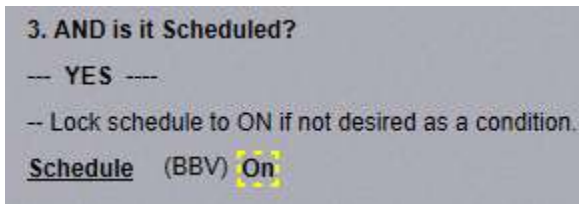

**NOTE** In order to lock the Schedule microblock from the **Properties** page, you must select **Show Service Config** view.

- 4 Verify the outdoor air conditions are met. OAT must be greater than the configured value.

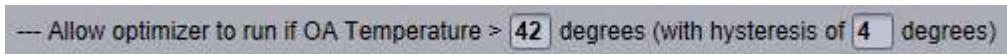

- 5 The part load conditions are met.

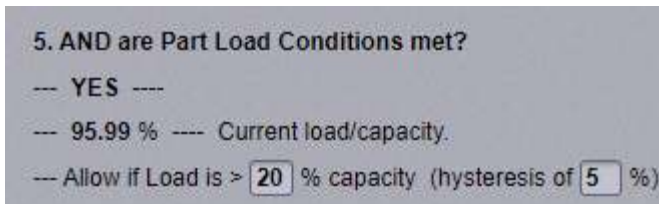

- 6 The current chilled water delta temperature is greater than the configured limit.

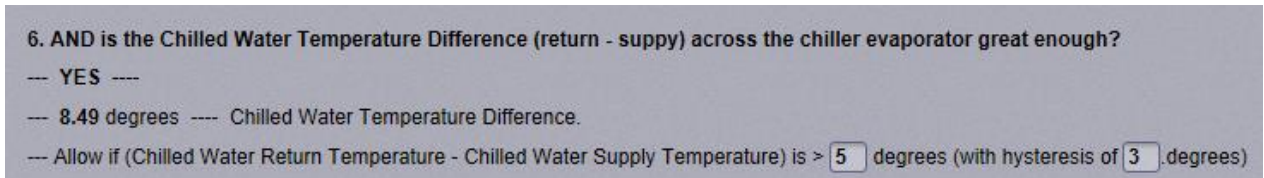

- 7 Verify all delays are sufficient.

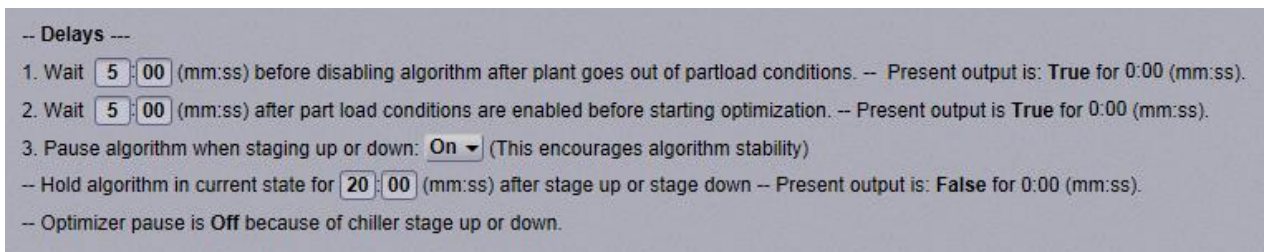



**NOTE** We highly recommended that you set **Pause algorithm when staging up or down** to **On** when the plant has multiple chillers. We recommend you initially set the **Hold algorithm** delay time to between 15 and 20 minutes. Adjust as required. Delay time should allow enough time for the plant to stabilize after a chiller is started or stopped.



**CAUTION** Even though the plant is now ready to be enabled, do **not** enable it yet.

**Section 2 - Chiller System Power, Efficiency, and Thermal Load Input and Status** (page 63)

- Verify all the power inputs are displaying proper values for all available devices - chiller(s), pump(s) and AHU fan(s).
- Verify all running chiller(s) are showing the appropriate statuses (Off/On).

**Section 3 - Stagger Reset – Enable Conditions** (page 65)

Verify **Lead / Lag - Stagger routine for optimization Is: Off**.

**NOTE** Stagger reset should only be **On** after both the **Chilled Water Optimizer Reset** and the **Condenser Water Optimizer Reset** are commissioned and enabled.

**Section 4 – Optimizer Setpoint Change Mode** (page 66)

- Select **Optimizer Is In: AUTOMATIC mode** to enable automatic setpoint change.
- Select **Optimizer Is In: MANUAL mode** to enable only manual setpoint change.

**NOTE** Use **MANUAL** mode with caution and only if you thoroughly understand its operation.

## Chilled water temperature optimizer reset

---

After you have completed the sequence specified in the General Conditions and Status section, then commission the *Chilled Water Temperature Optimizer Reset* (page 68).

- 1 Before commissioning the **Chilled Water Temperature Optimizer Reset**, verify that **Condenser Water Temperature Optimizer Reset > Section 1 - Condenser Water System Optimizer - Enable Conditions > CWS Optimizer ON Switch** (page 60) is set to **DISABLED**.

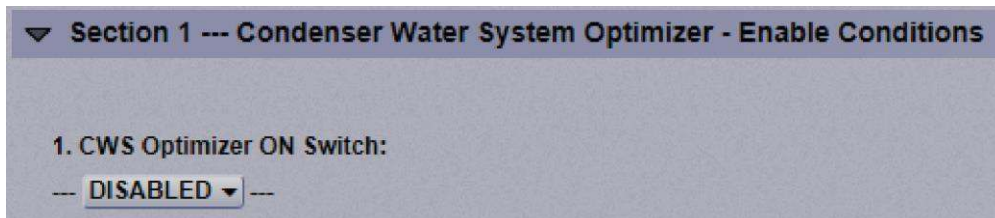

- 2 Verify the condenser water temperature setpoint is held constant.

## Sequence

Expand **Chilled Water Temperature Optimizer Reset** for the following:

### Section 1 - Chilled Water System Optimizer – Enable Conditions (page 69)

Verify **CHWS Optimizer ON Switch** is set to **DISABLED**.

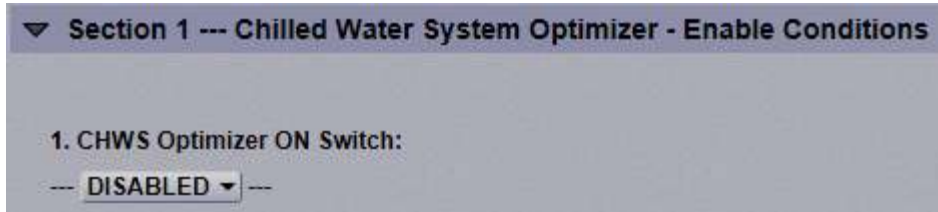

### Section 2 - Automatic Overrides of Chilled Water Reset (page 70)

Verify the following:

- Automatic "Pause & Hold"** override conditions have been set appropriately to match the system's operating requirements.
- The pause status displays: **Pause & Hold Is: OFF**. If it is on, then determine which condition is causing it to display **ON** and correct as necessary.

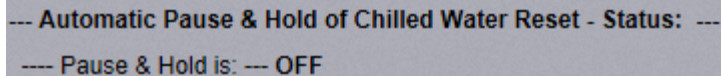

- Automatic "Quick Cool Down"** conditions have been set appropriately to match the system's operating requirements. We suggest you utilize the default values initially unless changes are required.
- The cool down status displays **Quick Cool Down Is: OFF**. If it is on, then determine which condition is causing it to display **ON** and correct as necessary.

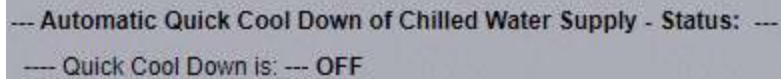

### Section 3 - Manual Overrides of Chilled Water Reset – and other Settings

Verify the following:

- Manual "Reinitialize" & "Pause & Hold"** are both **Off**.

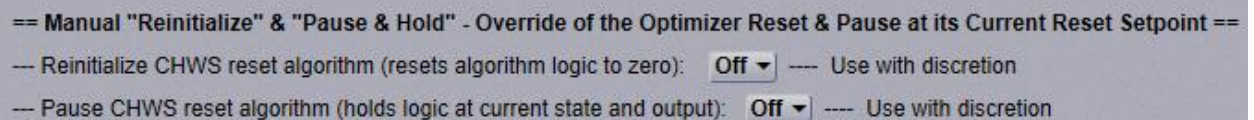

2 **Quick Cool Down:** is **Off**.

== Manual "Quick Cool Down" - Override of the Optimizer Reset & Lower the Supply Temperature Setpoint ==  
-- Quick Cool Down (lowers chws temperature): Off ▾

3 **Quick Cool Down incremental drop:** \_\_\_(deg) is the value used for each interval when quick cool down is required. Use the default value initially and adjust as required.

4 Initially use the default value 1.25 (deg) for the **First Reset**. Adjust after observing the response. This value should be between 0.7 and 2.0 (deg).

5 Input Smoothing is reasonable

**NOTE** You should start with the default of 50 and then fine tune it according to your system after it has been running for a while.

6 **System Response Time in minutes** is set to the default initial response time of 15 minutes.

**NOTE** Start with 10 / 15 minute value for a small / medium commercial building.

7 Set **Minimum and Maximum Reset Increments & Algorithm Reset Gains**, starting with:

- o Minimum Reset = 1 (deg)
- o Maximum Reset = 2 (deg)
- o Reset Increment Coarse Gain = 5
- o Reset Increment Fine Gain = 0

**NOTE** Adjust if required.

8 **Bias for reset of CHWS temperature setpoint for warmer temperatures** are off at this time.

9 **Reset Output** is setup for the actual setpoint range of the desired chilled water supply temperature. Use the default range of 42 degrees to 52 degrees as a start, or fine tune to your system requirements.

10 Select **NO** for the **Current Setpoint Input > Use the chilled water supply temperature (CURR STPT IN) as the optimizer starting setpoint?**

## Chilled water optimizer reset - Start-up

---

After you have completed the check out and verification of both the **General Conditions & Status** and the **Chilled Water Temperature Optimizer Reset**, enable the optimizer.

### To Start & Run the Optimizer

**General Conditions & Status > Section 1 - Optimizer – Primary Enable Conditions** (page 60)

1 All the enable conditions must be **On**.

2 Set the **Main ON Switch** to **ENABLED**.

**NOTE** This switch ONLY enables the program, but not the individual reset functions. Continue below to enable the chilled water reset function.

**Chilled Water Temperature Optimizer Reset > Section 1- Chilled Water System Optimizer – Enable Conditions**  
(page 63)

Set the **CHWS Optimizer ON Switch** to **ENABLED**.

**NOTES**

- This switch enables the chilled water reset portion of the program.
- You can observe the changing supply water temperature setpoint as the program searches for a lower energy consumption point.

**Chilled Water Temperature Optimizer Reset > Section 3 - Manual Overrides of Chilled Water Reset - and other Settings**

- 1** First response period — first reset
  - After one response period, the temperature is raised by the amount specified in **First Reset**.
  - The program waits for the second response period. During the second response, the program measures whether the first reset reduced the power consumption.
- 2** Second response period — second reset
  - After the second response period, the program resets the temperature again by a calculated amount.
  - If the first reset lowered power demand, then the program recognizes it is resetting in the correct direction. Since the first reset raised the supply temperature, then the second reset will again raise the chilled water supply temperature.
  - If the first reset increased power demand, then the program recognizes it is resetting in the wrong direction. Since the first reset raises the supply temperature, then the second reset lowers the chilled water supply temperature.
- 3** Third and successive responses — The program will repeat the above process and continue to reset the chilled water supply temperature by a new calculated amount. The program continually searches for the chilled water supply temperature that maximizes energy savings at the chiller with any increased energy use at the pumps and fans.

## Chilled water optimizer reset - Tuning

---

One of the most important settings in the program is the time it takes for the chilled water system to respond after the optimization program resets the chilled water supply temperature setpoint.

The program needs to recognize if the system is using less energy after the setpoint has changed. The response time is the period that it takes the system to achieve and stabilize at a new setpoint and allow enough time for the total system power to stabilize at its new demand level.

Adequate response depends on each reset increment being large enough for the chilled water system to react. The system may not recognize increments that are too small. To make the increment large enough, start the minimum increment between 1° to 1.5°F and the maximum increment at least 1°F above that.

It is difficult to approximate the response time. If the response time is too small, the optimization program does not get an accurate measurement of the new energy use because the demand is still changing.

**NOTE** It is always better to be high rather than low when setting the response time.

You can trend various points (i.e., chiller leaving supply temperature, pump speeds, chilled water valve positions) to get a better estimate of the response time.

**NOTE** The nominal response time is between 15 and 20 minutes. For smaller water loops in small or medium-sized commercial buildings, it may be lowered, but only after the timing is verified. Otherwise, unstable operation may occur.

You can get an approximation of the response time by locking the chilled water reset signal in **Chilled Water Temperature Optimizer Reset** (page 68) > **Optimized Chilled Water Supply Setpoint AV** to a value between 40 and 50°F and 3°F higher than the current value, then verifying response in the chiller manager program. The response time will be larger than the time it takes to achieve the temperature rise of 3°F. It includes the total time it takes for everything below to occur:

- The time it takes for the chilled water supply temperature to reach the new temperature
- The time it takes after the water temperature has stabilized for the air handling unit valves to open or close, based on new chilled water temperature
- The pumps have reached their new speed in response to valves opening
- The air handler supply air temperature has risen or dropped (if applicable)

All the changes in consumption (kW) above result from the chilled water setpoint change. The effect of this change must propagate through all the devices in the system until it is stable. You may need to tune some chiller programs or properties to get a proper response. It is important that the chilled water setpoint be reset predictably and quickly enough for the optimization program to work reliably. Good response is essential and the actual response time depends on the system.

## Make adjustments

### Section 3 - Manual Overrides of Chilled Water Reset - and other Settings > Minimum & Maximum Reset Increments & Algorithm Reset Gains

After the program has been running awhile, adjust the **Minimum Reset Increment** and **Maximum Reset Increment** as shown below, if necessary.

- **Minimum Reset Increment**
  - If the chilled water system is not responding to each supply temperature increment, it could be the minimum reset increment is too small. If so, increase it by 0.5 (deg) above its current value.
  - If the system is still not responding to each temperature increment, increase it by another 0.5 (deg).

**NOTE** Setting the minimum reset increment to more than 1.75 (deg) may cause overshoot. Set the minimum to match your system and chiller type, as some chillers require a larger minimum increment.
- **Maximum Reset Increment**
  - If the chilled water system is responding too much for each supply temperature increment, the maximum reset increment is too high. Decrease it by 0.5 (deg) below its current property value.
  - If the system is still responding too much for each temperature increment, decrease it by another 0.5 (deg). It is preferable to have the **Maximum Reset Increment** at least 1.5 (deg) above the **Minimum Reset Increment**.

### Reset Gain

**Reset Gain** and the **Minimum and Maximum Reset Increments** are interdependent and you might need to adjust both more than once. The reset gain determines the reset increment and the chilled water supply temperature.

After the program has been running a while and if each increment is often at either the minimum or maximum, then you can adjust the Reset Gain.

- Each reset increment should fall **between** the minimum and maximum limits
- The reset increment frequently increases over a response period, which is normal
- If most often at the **Minimum Reset Increment**, then raise the reset gain
- If most often at the **Maximum Reset Increment**, then lower the reset gain

### Optional - Bias for warmer Chilled Water Supply Temperatures

After the program has been running a while, the chilled water temperature could be running cooler than expected. This could be any one of the following reasons:

- It is the best temperature for optimum energy use
- The system power, flows, or tonnage inputs are turbulent and fluctuate irregularly
- There is a piping or design issue
- The program calculations could be misconfigured

**NOTE** Smoothing can help address the problem caused by turbulence or fluctuations in measurements.

If you are concerned about cooler temperatures:

- Add smoothing and give a bias toward warmer supply temperatures and energy savings at the chiller(s) by turning each Bias switch to On.
- Fine tune the Bias, for lower energy savings at the chiller versus lower "system wide" energy savings.

## Condenser water optimizer reset

---

Before starting this section, you must have already completed the sequence specified in General conditions and status and completed the Chilled water optimizer reset.

Before commissioning the **Condenser Water Temperature Optimizer Reset**, verify the **Chilled Water Temperature Optimizer Reset > Section 1. Chilled Water System Optimizer - Enable Conditions** (page 69) > **CHWS Optimizer ON Switch** is set to **DISABLED**.

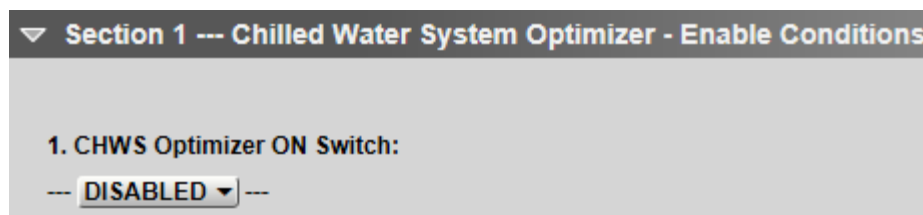

## Sequence

Expand **Condenser Water Temperature Optimizer Reset** for the following:

### Section 1 - Condenser Water System Optimizer – Enable Conditions (page 82)

Verify **CWS Optimizer ON Switch** is set to **DISABLED**.

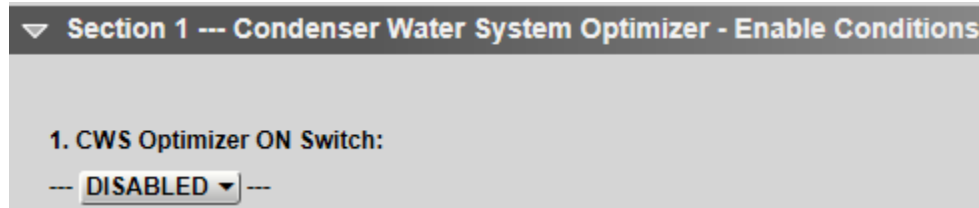

### Section 2 - Manual Overrides of Condenser Water Reset (page 83)

Verify the following:

- 1 **Manual "Reinitialize" & "Pause & Hold"** are both **Off**.

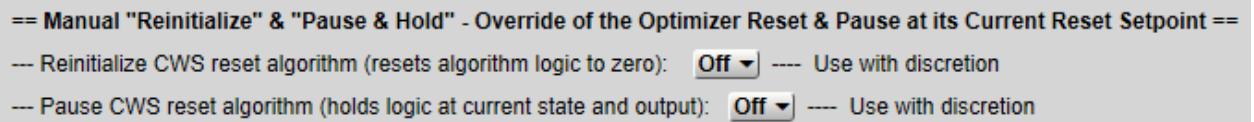

- 2 **Manual "Quick Warm Up"** conditions have been set appropriately to match the system's operating requirements. We recommend that you use the default values initially unless changes are required.
- 3 The quick warm up status displays **Quick Warm Up is: OFF**. If it is on, then determine which condition is causing it to display ON and correct as necessary.
- 4 Configure the **First Reset** by initially using the default value of 6 (deg). Adjust after observing the response.

**NOTE** This value should be between 4.0 and 8.0 (deg).

**EXAMPLE** Your default **Resting** temperature (**Condenser Water Optimizer Operation Overview - Notes > Condenser Water Supply Setpoint Range - Based on OA Wet Bulb Temperature** (the condenser water supply temperature setpoint when the optimizer is off) is set to 8 degrees above wet bulb. Your **First Reset** priming temperature might be 7 degrees above wet bulb. This first reset would lower the condenser water supply temperature by 1 degree (from 8 degrees to 7 degrees above wet bulb). This would result in the fans running slightly faster (increasing energy use at the fans) and lowering the lift slightly at the chiller (reducing energy demand at the chiller). This **First Reset** starts the optimization program in its search for lower energy use and balancing lower energy demand at the chiller with higher energy demand at the tower fans (and any variable flow pumps).

- 5 Initially start with a default Input Smoothing value of 50 and then fine tune it according to your system.

- 6 **System Response Time In minutes:** is set to the initial response time.

**NOTE** Start with 5 minutes for a facility where the cooling towers are near the chiller, and 8 to 10 minutes for a facility where they are remote.

- 7 Set **Minimum and Maximum Reset Increments & Program Reset Gains**, starting with:
- Minimum Reset = 1 (deg)
  - Maximum Reset = 2 (deg)
  - Reset Increment Gain = 5
  - Reset Increment Fine Gain = 0
- NOTE** You may need to change these later.
- 8 Ensure your **Bias for reset of CWS temperature setpoint for cooler temperatures** are off at this time. You can always turn them on later.

### Section 3 - Condenser Water Setpoint Reset – Output & Limit Settings (page 83)

- 1 Configure the **Condenser Water Supply Setpoint Range – Based on OA Wet Bulb Temperature**, starting with:
- **Maximum: Wet Bulb Approach:** 11 degrees – Setpoint at lowest reset (warmest condenser water temperature) when the tower fans run the slowest.
  - **Resting: Wet Bulb Approach:** 8 degrees – Setpoint when the optimizer is off.
  - **Minimum Wet Bulb Approach:** 5 degrees – Setpoint at highest reset (coolest condenser water temperature) when the tower fans are running faster.
- NOTE** You may need to change these later.
- Configure the **Condenser Water Supply Temperature – High Limits** appropriate for your chiller. You may need to adjust the defaults .
  - Configure the **Condenser Water Supply Temperature – Low Limits** appropriate for your chiller. You may need to adjust the defaults .

## Condenser water optimizer reset - Start-up

---

After you have completed the check out and verification of both **General Conditions and Status** and **Condenser Water Temperature Optimizer Reset**, enable the optimizer.

### To start and run the Chilled Water System Optimizer

#### General Conditions & Status > Section 1 - Optimizer – Primary Enable Conditions (page 60)

- All the enable conditions must be **On**.
- Set the **Main ON Switch** to **ENABLED**.

**NOTE** This switch ONLY enables the program, but not the individual reset functions. Continue below to enable the condenser water reset function.



**Condenser Water Temperature Optimizer Reset > Section 1- Condenser Water System Optimizer – Enable Conditions** (page 82)

Set the **CWS Optimizer ON Switch** to **ENABLED**.

**NOTE** This switch enables the condenser water reset portion of the program.

You can observe the changing condenser water temperature setpoint as the program searches for a lower energy consumption point.

**Condenser Water Temperature Optimizer Reset > Section 2 - Manual Overrides of Condenser Water Reset - and other Settings** (page 83)

- 1** First response period – first reset
  - After one response period, the temperature is raised by the amount specified in **First Reset**.
  - The condenser water temperature should be lower than the **Resting Wet Bulb Approach** defined in **Section 3 - Condenser Water Setpoint Rest - Output & Limit Settings > Condenser Water Optimizer Operation Overview - Notes > Resting Wet Bulb Approach.**>
  - The program waits for the second response period. During the second response, the program measures whether the First Reset temperature reduced the power consumption.
- 2** Second response period – second reset
  - After the second response period, the program resets the temperature again by a calculated amount.
  - If the first reset lowered power demand, then the program continues resetting in the same direction.
  - If the first reset increased power demand, then the program recognizes it is resetting in the wrong direction. Since the first reset lowers the supply temperature, then the second reset raises the condenser water supply temperature.
- 3** Third and successive responses – The program will repeat the above process and continue to reset the condenser water temperature setpoint by a new calculated amount. The program continually searches for the condenser water temperature that best balances energy savings at the chiller with increased energy use at the condenser water pumps and tower fans.

## Condenser water optimizer reset - Tuning

---

One of the most important settings in the program is the time it takes for the condenser water system to respond after the optimization program resets the temperature.

The program needs to recognize if the system is using less energy after the setpoint has changed. The response time is the period that it takes the system to achieve and stabilize at a new setpoint and allow enough time for the total system power to stabilize at its new demand level.

Adequate response depends on each reset increment being large enough for the condenser water system to react. The system may not recognize increments that are too small. To make the increment large enough, start the minimum increment between 1° to 1.5°F and the maximum increment at least 1° to 1.25°F above that.

It is difficult to approximate the response time. If the response time is too small, the optimization program does not get an accurate measurement of the new energy use because the demand is still changing.

**NOTE** It is always better to be slightly high rather than low when setting the response time.

You can trend various points (i.e., condenser water supply temperature, tower fan, and pump speeds) to get a better estimate of the response time.

**NOTE** For chilled water facilities where the towers are close to the chillers, the response time may be between 4 and 8 minutes. For other facilities, where the towers are more remote, the response time may be higher.

You can get an approximation of the response time by locking the condenser water reset signal **Condenser Water Temperature Optimizer Reset > Optimized Condenser Water Supply Temperature AV (wetb + approach)** to a value 3°F higher or cooler than current setpoint and then verifying response in the tower manager program. This should result in a temperature change of 3°F. It also includes the total time it takes for everything below to occur:

- The time it takes for the condenser water supply temperature to reach the new temperature setpoint
- The time it takes for the tower fans to settle to a new speed based on the new condenser water temperature setpoint
- The condenser water pumps (if variable flow) have reached their new speed in response to the new temperature

All the changes in consumption (kW) are due to the condenser water setpoint change. The effects of the setpoint change must propagate through the entire condenser water system until all devices in the system become stable. You may need to tune certain tower or pump program properties, such as PID control loop gains and ramp rates to get proper response. It is important that the condenser water setpoint be reset predictably and quickly enough for the optimizer to work reliably. Good response is essential and the actual response time depends on the system.

## Adjustments - Minimum & Maximum Increments and Reset Gain

After the program has been running a while, adjust the Minimum Increment and Maximum Increment as shown below, if necessary.

### Minimum Reset Increment

- If the condenser water system is not responding to each incremental temperature setpoint change, it could be the minimum reset increment is too small. If so, increase it by 0.5 (deg) above its current property value.
- If the system is still not responding to each incremental change, increase it by another 0.5 (deg).

**NOTE** Never set the reset increment to more than 1.75 (deg). Values above this may cause overshoot.

### Maximum Reset Increment

- If the condenser water system is responding too much for each incremental change, the maximum reset increment is too high. Decrease it by 0.5 (deg) from its current value.
- If the system is still responding too much for each temperature increment, decrease it by another 0.5 (deg). It is preferable to have the **Maximum Reset Increment** be at least 0.5 (deg) above the **Minimum Reset Increment**.

## Reset Gain

**Reset Gain** and the **Minimum and Maximum Reset Increments** are interdependent and you might need to adjust both more than once.

The reset gain determines the reset increment and, consequently, the condenser water supply temperature.

After the program has been running a while and if each increment is often at either the minimum or maximum, then you can adjust the Reset Gain.

- Each reset increment should fall **between** the minimum and maximum limits
- The reset increment frequently increases over a response period, which is normal
- If most often at the Minimum Increment, then raise the reset gain
- If most often at the Maximum Increment, then lower the reset gain

## Optional - Add Bias for cooler Condenser Water Supply Temperatures

After the program has been running a while, the condenser water temperature could be running warmer than expected. This could be any one of the following reasons:

- It is the best temperature for optimum energy use
- The system power, flows, or variable fan speed drives are turbulent or fluctuate irregularly
- There is a piping or design issue
- The program calculations could be misconfigured

**NOTE** Smoothing can help address the problem, but may not completely remove the impact on the calculations.

If you are concerned about warmer temperatures:

- Add smoothing and give a bias toward cooler water and energy savings at the chiller(s), turn each Bias switch to On.
- Fine tune the Bias, for lower energy savings at the chiller versus lower "system wide" energy savings.

## Device Address Binding

**Device Address Binding** (DAB) allows the Chilled Water System Optimizer to send and receive data to and from other controllers when they are connected to a BAS network. The data transfer takes the form of DAB, which you must configure.

Currently, the controller implements DAB for the following variables:

- **0.1 Plant ON**
- **1 CH1 kW**
- **1 CH1 ON**
- **2 CH2 kW**
- **3 CH3 kW**
- **3 CH3 ON**
- **4 CH4 kW**
- **4 CH4 ON**
- **5 CH5 kW**
- **6 CH6 kW**
- **6 CH6 ON**
- **7 CH7 kW**
- **7 CH7 ON**
- **8 CH8 kW**
- **8 CH8 ON**
- **9 CHW Pump kW**
- **10 AHU VAV Fan kW**
- **11 CWP kW**
- **12 CW Tower Fan kW**
- **13 CHW Flow**
- **13 CHWR Temp**
- **13 CHWS Temp**
- **13 Cooling Load**
- **15 Building Relative Humidity**
- **16 CHWS STPT TEMP (REMOTE INPUT)**
- **16 CHWS TEMP (REMOTE INPUT)**
- **16 Curr Stpt IN**
- **16 Optimized CHWS Reset Heartbeat ANO Minutes**

**NOTE** Recommended, but not required

- **17 CWS FLOW (REMOTE INPUT)**
- **17 CWR TEMP (REMOTE INPUT)**
- **17 CWS STPT TEMP (REMOTE INPUT)**
- **17 CWS TEMP (REMOTE INPUT)**
- **17 Optimized CWS Reset Heartbeat ANO Minutes**  
**NOTE** Recommended, but not required
- **Outdoor Air Humidity**
- **Outdoor Air Temperature**

You can implement DAB on network points with an undefined BACnet address, displayed in Field Assistant and the i-Vu® interface on the **Properties** page > **Network Points** tab. See example below.

Name	Type	Value	Locked	Default Value	Com Enabled	COV Enable	Refresh Time (mm:ss)	Address	Error
System Outdoor Air Temperature	(ANI2)	-999.00	<input type="checkbox"/>	-999	<input checked="" type="checkbox"/> All		10   00	bacnet://	0 No Error
(Primary)								bacnet://	0 No Error
(Secondary)								bacnet://	0 No Error

Undefined BACnet address  
Currently "unbound"

Name	Type	Value	Locked	Default Value	Com Enabled	COV Enable	Refresh Time (mm:ss)	Address	Error
System Outdoor Air Temperature	(ANI2)	88.80	<input type="checkbox"/>	-999	<input checked="" type="checkbox"/> All		10   00	bacnet://1610151/AV:80001	0 No Error, bound to DEV:1610151, AV:80001
(Primary)								bacnet://1610151/AV:80001	0 No Error, bound to DEV:1610151, AV:80001
(Secondary)								bacnet://1610151/AV:80001	0 No Error, bound to DEV:1610151, AV:80001

Device Address Variable Number

Indicates successful binding

## Configuring the Chilled Water System Optimizer's Properties page

In the i-Vu® interface, on the controller's **Properties** page, you can select 4 different options to view and configure properties and points.

You can select from the following views:

- **Status only** – Displays the current values or state of points and properties applicable to monitoring the controller.
- **Service Config** – For making basic user changes to configuration.
- **Commissioning** – For commissioning and start-up.
- **Commissioning+Notes** – Incorporates explanations added to the Commissioning view.

## Compliance

### CE Compliance

---

 **WARNING** This is a Class A product. In a domestic environment, this product may cause radio interference in which case the user may be required to take adequate measures.

### FCC Compliance

---

This equipment has been tested and found to comply with the limits for a Class A digital device, pursuant to Part 15 of the FCC Rules. These limits are designed to provide reasonable protection against harmful interference when the equipment is operated in a commercial environment. This equipment generates, uses, and can radiate radio frequency energy and, if not installed and used in accordance with the instruction manual, may cause harmful interference to radio communications. Operation of this equipment in a residential area is likely to cause harmful interference in which case the user will be required to correct the interference at his own expense.

 **CAUTION** Changes or modifications not expressly approved by the responsible party for compliance could void the user's authority to operate the equipment.

### BACnet Compliance

---

Compliance of listed products to requirements of ASHRAE Standard 135 is the responsibility of BACnet International. BTL® is a registered trademark of BACnet International.

## Appendix A: The Chilled Water System Optimizer – Status only view of the Properties page

The following properties and points show only the current value or state. For more information, select the **Service Config** or **Commissioning** view.

See *Appendix B* (page 58) for a list of default values and ranges for the properties.

### At the top of the Properties page, there is a quick overview of system statuses

ENABLED/DISABLED – Optimizer

ENABLED/DISABLED – Chilled Water Supply Reset

\_\_\_ degrees = Setpoint

\_\_\_ degrees = Supply Temperature

\_\_\_ degrees = Return Temperature

ENABLED/DISABLED – Condenser Water Supply Reset

\_\_\_ degrees = Setpoint

\_\_\_ degrees = Temperature

\_\_\_ degrees = Outdoor Air Temperature

\_\_\_ degrees = Outdoor Air Wet Bulb

\_\_\_ degrees = Total Demand

\_\_\_ degrees = Load

\_\_\_ degrees = Efficiency



## General Conditions & Status

Navigation: i-Vu®

Properties > Control Program > General Conditions & Status

Point Name/Description
<b>Optimizer Enable</b> — Displays ENABLED or DISABLED status.
<b>Outdoor Air Temperature</b> — Allows this controller to use an outdoor temperature value from another controller over the network. The remote controller must be equipped with a network-accessible sensor value. Allows lockout if <b>Lock at value:</b> is checked. Allows communication if <b>Enabled?:</b> is checked.
<b>Outdoor Air Humidity</b> — Allows using another controller's relative humidity value over the network. The remote controller must be equipped with a network-accessible value. Allows lockout if <b>Lock at value:</b> is checked. Allows communication if <b>Enabled?:</b> is checked.
<b>Outdoor Air Wet Bulb Temperature</b> — Displays the calculated value based on the OA temperature and OA humidity values.
<b>Total Chilled &amp; Condenser Water System kW</b> — Displays the current value of all the monitored energy loads.
<b>Total Building Cooling Load Tons</b> — Displays the current value of all the monitored chilled water system thermal load
<b>Total Chilled &amp; Condenser Water System kW/ton</b> — Displays the current value of all the monitored energy loads as a function of the operating thermal load of the plant.

## Section 1 - Optimizer - Primary Enable Conditions

Navigation: i-Vu®

Properties > Control Program > General Conditions & Status > Section 1 - Optimizer - Primary Enable Conditions

Point Name/Description
<b>Chilled Water System Optimizer Allowed to Run under the Following "Primary Enable Conditions"</b>
<b>PRIMARY ENABLE CONDITIONS</b>
<b>1. Is the Main ON Switch Enabled?</b> — Displays the status of the master switch that enables the entire optimization program.
<b>2. AND Is the Plant is ON via the "Plant ON" binary network input?</b> — This input runs the optimization program only when the plant is appropriately enabled and running. <b>AND Is at least one chiller running?</b> - Displays YES or NO status. <b>Chiller(s) running</b> - Number of running chillers
<b>3. AND Is It Scheduled?</b> — Link to a BACnet Binary Value that indicates the chiller manager (or chiller, if single chiller only) is running. Displays YES or NO status.

Point Name/Description
<b>4. AND are outdoor air conditions met?</b> — Set the outside air temperature enable conditions to stabilize the program when the weather is warm enough for the chiller plant to stabilize. - Displays YES or NO status.
<b>__ degrees — Outdoor Air Temperature</b> — Displays current OAT
<b>5. AND are Part Load Conditions met?</b> — Set the part load conditions to fit your chiller plant. The program defaults to run when the chiller plant is operating above 20%.  If the reset is applied at very low load conditions, the plant may cycle off more frequently when on low load or low delta temperature. The program starts to cool down to lowest chilled water supply temperature when the load is below the low threshold. - Displays YES or NO status.
<b>_.__% Current load/capacity</b> — Displays value.
<b>6. AND is the Chilled Water Temperature Difference (return-supply) across the chiller evaporator great enough?</b> — Set a minimum allowed temperature across the evaporator so the temperature difference will not drop too low. This prevents the chiller from cycling off on low load too often and helps to stabilize chiller operation. The optimization program will not start until the temperature drop across the evaporator is large enough. - Displays YES or NO status.
<b>Chilled Water Temperature Difference</b> — Displays delta temperature in degrees
<b>Loss of Communications Lockout Conditions</b>
<b>Loss of Network Communications Conditions</b>
<b>Optimizer __ latched off due to comm loss</b> — Displays status.
<b>Time since loss of comm _:_ (mm:ss)</b> — Displays status.
<b>Number of comm losses this period __</b> — Displays value.
<b>Time since first loss of comm _:_ (mm:ss)</b> — Displays value.
<b>Alarm(s):</b>
<b>COMMLOSS (BALM) Loss of Comm Alarm</b> — Displays Off/On communication alarm status.
<b>SENSOR (BALM) __ Sensor Out of Range</b> — Displays Off/On status.

## Section 2 - Chiller System Power, Efficiency, and Thermal Load Input Status

---

Navigation: i-Vu@

**Properties > Control Program > General Conditions & Status > Section 2 - Chiller System Power, Efficiency and Thermal Load Input Status**

- Verify network connections are operating. See *Device Address Binding* (page 45).
- Input the nominal chiller capacities (tons) required to determine part load conditions.
- Select whether the power input is actual kW or amperage.
- Select load input type using temperatures and flow or cooling load input.

Point Name/Description
The following are status displays from the linked network points. See <i>Device Address Binding</i> (page 45).
<b>Total Chiller kW</b> – Displays value.
<b>Total Chilled Water Pump kW</b> – Displays value.
<b>Total Condenser Water Pump kW</b> – Displays value.
<b>Total Cooling Tower Fan kW</b> – Displays value.
<b>Total Airside Fan kW</b> – Displays value.
<b>Total System kW (Chillers + CHWPs + CWPs + CTs + Fans)</b> – Displays value.
<b>Total Building Cooling Load Tons</b> – Displays value.
<b>Total System kW/ton</b> – Displays value.

## Section 3 - Stagger Reset - Enable Conditions

Navigation: i-Vu®

**Properties > Control Program > General Conditions and Status > Section 3 - Stagger Reset - Enable conditions**

Stagger Reset is only enabled when both Chilled Water Reset and Condenser Water Reset are running

Stagger Reset alternates between the chilled water reset and the condenser water reset calculations. When on, the program first resets the chilled water supply temperature and calculates its impact on decreasing energy demand. It then resets the condenser water temperature and calculates its impact on decreasing energy demand. This is a lead-lag approach.

If both chilled water and condenser water optimizer reset calculations are done simultaneously, the program would not know whether the chilled water reset alone decreased energy demand, or the condenser water reset decreased energy demand. Temperatures might be reset in the wrong direction.

Point Name/Description
<b>Lead / Lag - Stagger routine for optimization is: __</b> – Displays On/Off status.
<b>Condenser Water Optimization Reset is now ___ in the stagger routine.</b> – Displays Held off or Running status.
<b>Chilled Water Optimization Reset is now ___ in the stagger routine.</b> – Displays Held off or Running status.

## Chilled Water Temperature Optimizer Reset

---

Navigation: i-Vu®

**Properties > Control Program > Chilled Water Temperature Optimizer Reset**

Point Name/Description
<b>Optimizer Chilled Water Supply Reset Enable</b> – Displays status.
<b>Optimized Chilled Water Supply Setpoint AV</b> – Displays status.
<b>Total Chiller kW/ton</b> – Displays value.
<b>Total Chilled Water Pump kW/ton</b> – Displays value.
<b>Total Airside Fan kW/ton</b> – Displays value.
<b>Total Chilled Water System kW/ton</b> – Displays value.

## Section 1 - Chilled Water System Optimizer - Enable conditions

---

Navigation: i-Vu®

**Properties > Control Program > Chilled Water Temperature Optimizer Reset > Section 1 - Chilled Water System Optimizer - Enable Conditions**

Point Name/Description
<b>1. CHWS Optimizer ON Switch:</b> – Displays Disabled/Enabled status.

## Section 2 - Automatic Overrides of Chilled Water Reset

---

Navigation: i-Vu®

**Properties > Control Program > Chilled Water Temperature Optimizer Reset > Section2 - Automatic Overrides of Chilled Water Reset**

Point Name/Description
<b>Automatic Pause &amp; Hold of Chilled Water Reset - Status</b>
<b>Pause &amp; Hold Is: __</b> – Displays OFF/ON status.
<b>Automatic Quick Cool Down of Chilled Water Supply - Status:</b>
<b>Quick Cool Down Is: ___</b> – Displays OFF/ON status.

## Section 3 - Manual Overrides of Chilled Water Reset - and other Settings

Navigation: i-Vu®

**Properties > Control Program > Chilled Water Temperature Optimizer Reset > Section 3 - Manual Overrides of Chilled Water Reset - and other Settings**

Point Name/Description
<b>Manual Pause &amp; Hold of Chilled Water Reset</b>
<b>Pause &amp; Hold Is:___</b> — Displays OFF or ON status.
<b>Manual Quick Cool Down of Chilled Water Supply</b>
<b>Quick Cool Down Is: __</b> — Displays OFF or ON status.

## Condenser Water Temperature Optimizer Reset

Navigation: i-Vu®

**Properties > Control Program > Condenser Water Temperature Optimizer Reset**

Point Name/Description
<b>Optimizer Condenser Water Supply Reset Enable</b> — Displays ENABLED or DISABLED status.
<b>Optimized Condenser Water Supply Setpoint AV (wetb + approach) (BAV)</b> — Displays value.
<b>Outdoor Air Wet Bulb Temperature</b> — Displays value.
<b>Optimized Condenser Water Supply Setpoint (calculated approach) (BAV)</b> — Displays value.
<b>Total Chiller kW/ton</b> — Displays value.
<b>Total Condenser Water Pump kW/ton</b> — Displays value.
<b>Total Cooling Tower Fan kW/ton</b> — Displays value.
<b>Total Condenser Water System kW/ton</b> — Displays value.

## Section 1 - Condenser Water System Optimizer - Enable Conditions

---

Navigation: i-Vu®

**Properties > Control Program > Condenser Water Temperature Optimizer Reset > Section 1 - Condenser Water System Optimizer - Enable Conditions**

Point Name/Description
<b>1. CWS Optimizer ON Switch:</b> – Select ENABLED or DISABLED.

## Section 2 - Manual Overrides of Condenser Water Reset - and other Settings

---

Navigation: i-Vu®

**Properties > Control Program > Condenser Water Temperature Optimizer Reset > Section 2 - Manual Overrides of Condenser Water Reset - and other Settings**

Point Name/Description
<b>Manual Pause &amp; Hold of Condenser Water Reset</b>
<b>Pause &amp; Hold Is __</b> – Displays OFF or ON status.
<b>Manual Quick Warm Up of Condenser Water Supply</b>
<b>Quick Warm Up Is:</b> – Displays OFF or ON status.

## Section 3 - Condenser Water Setpoint Reset - Output & Limit Settings

---

Navigation: i-Vu®

**Properties > Control Program > Condenser Water Temperature Optimizer > Section 3 - Condenser Water Setpoint Reset - Output & Limit Settings**

Point Name/Description
<b>Current Limits, Approach, Setpoints, and CWS Temperature Setpoint</b>
<b>Current High Limit Is:</b> – Displays value.
<b>Current High Approach Is:</b> – Displays value.
<b>Current Setpoint Is:</b> – Displays value.
<b>Current Low Approach Is:</b> – Displays value.
<b>Current Low Limit Is:</b> – Displays value.

## Electric Metering - Combined kW of Monitored Equipment

Navigation: i-Vu®

**Properties > Control Program >  
Electric Metering - Combined kW of Monitored Equipment**

<b>Point Name/Description</b>
<b>Meter Input</b>
<b>Instantaneous Demand: __ kW</b> – Displays value of the instantaneous demand read by meters.
<p><b>Peak Demand History</b></p> <p>Displays the historical peak kW demand values recorded for various periods. Each period also indicates the time, date, and day of the occurrence <i>since the beginning of the evaluation period</i>.</p> <p>The following time period values are displayed in this format:          __. __ Kw on __ (hh:mm) on __/__/__ (mm/dd/yy) / day of the week  <b>since</b>          __: __ (hh:mm) on __/__/__ (mm/dd/yy) / day of the week</p>
<p><b>Daily Peak Demand</b></p> <p><b>Today</b> – Displays values and times in the above format.  <b>Previous Day</b> – Displays values and times in the above format.</p>
<p><b>Monthly Peak Demand</b></p> <p><b>Month-To-Date</b> – Displays values and times in the above format.  <b>Previous Month</b> – Displays values and times in the above format.</p>
<p><b>Yearly Peak Demand</b></p> <p><b>Year-To-Date</b> – Displays values and times in the above format.  <b>Previous Year</b> – Displays values and times in the above format.</p>
<p><b>Usage History</b></p> <p>Displays the historical accumulated energy usage values recorded for various periods as shown below.</p>
<p><b>Daily Usage</b></p> <p><b>Today</b> – Displays values.  <b>Previous Day</b> – Displays values.</p>
<p><b>Monthly Usage</b></p> <p><b>Month-To-Date</b> – Displays values.  <b>Previous Month</b> – Displays values.</p>

<b>Point Name/Description</b>
<b>Yearly Usage</b> <b>Year-To-Date</b> – Displays values. <b>Previous Year</b> – Displays values.



## Appendix B: The Chilled Water System Optimizer Commissioning view of the Properties page

**NOTE** Engineering units shown in this document in the defaults and ranges are strictly for reference. You must enter an integer only.



**CAUTION** You must disable the following before commissioning:

**1 General Conditions & Status**

Section 1: **Set Main ON Switch** to **DISABLED**.

**2 Chilled Water Temperature Optimizer Reset**

Section 1: Set the **CHWS Optimizer ON Switch** to **DISABLED**.

**3 Condenser Water Temperature Optimizer Reset**

Section 1: Set the **CWS Optimizer ON Switch** to **DISABLED**.

**At the top of the Properties page, there is a quick overview of system statuses**

ENABLED/DISABLED – Optimizer

ENABLED/DISABLED – Chilled Water Supply Reset

\_\_.\_\_ degrees = Setpoint

\_\_.\_\_ degrees = Supply Temperature

\_\_.\_\_ degrees = Return Temperature

ENABLED/DISABLED – Condenser Water Supply Reset

\_\_.\_\_ degrees = Setpoint

\_\_.\_\_ degrees = Temperature

\_\_.\_\_ degrees = Outdoor Air Temperature

\_\_.\_\_ degrees = Outdoor Air Wet Bulb

\_\_.\_\_ degrees = Total Demand

\_\_.\_\_ degrees = Load

\_\_.\_\_ degrees = Efficiency

## General Conditions & Status

Navigation: i-Vu®

Properties > Control Program > General Conditions & Status

Point Name/Description	Range
<b>Optimizer Enable</b> — Displays ENABLED or DISABLED status.	
<p><b>Outdoor Air Temperature</b>— Allows this controller to use an outdoor temperature value from another controller over the network. The remote controller must be equipped with a network-accessible sensor value.</p> <p>Allows lockout if <b>Lock at value:</b> is checked. Allows communication if <b>Enabled?:</b> is checked.</p>	<p>D: Unlocked (checked)</p> <p>D: Enabled (checked)</p>
<p><b>Outdoor Air Humidity</b> — Allows using another controller's relative humidity value over the network. The remote controller must be equipped with a network-accessible value.</p> <p>Allows lockout if <b>Lock at value:</b> is checked. Allows communication if <b>Enabled?:</b> is checked.</p>	<p>D: Unlocked (checked)</p> <p>D: Enabled (checked)</p>
<b>Outdoor Air Wet Bulb Temperature</b> — Displays the calculated value based on the OA temperature and OA humidity values.	
<b>Total Chilled &amp; Condenser Water System kW</b> — Displays the current value of all the monitored energy loads.	
<b>Total Building Cooling Load Tons</b> — Displays the current value of all the monitored chilled water system thermal load.	
<b>Total Chilled &amp; Condenser Water System kW/ton</b> — Displays the current value of all the monitored energy loads as a function of the operating thermal load of the plant.	R: 0 to 5 kW/Ton

## Section 1 - Optimizer - Primary Enable Conditions

Navigation: i-Vu®

**Properties > Control Program > General Conditions & Status > Section 1 - Optimizer - Primary Enable Conditions**

Point Name/Description	Range
<b>Chilled Water System Optimizer Allowed to Run under the Following "Primary Enable Conditions"</b>	
<b>PRIMARY ENABLE CONDITIONS</b>	
<p><b>1. Is the Main ON Switch Enabled?</b> — Displays the status of the master switch that enables/disables the entire optimization program.</p> <p><b>NOTES</b></p> <ul style="list-style-type: none"> <li>For initial setup, set to <b>DISABLED</b>.</li> <li>The chilled water supply reset and condenser water supply reset have their own enable switch.</li> </ul> <p> <b>CAUTIONS</b></p> <ul style="list-style-type: none"> <li>Only select <b>ENABLED</b> after the program is set up and ready to run</li> <li>This switch must be enabled in order for the Chilled Water System Optimizer to be enabled.</li> </ul>	<p>D: DISABLED</p> <p>R: ENABLED/DISABLED</p>
<p><b>2. AND Is the Plant ON via the "Plant ON" binary network Input?</b> — This input runs the optimization program only when the plant is appropriately enabled and running.</p> <p><b>AND is at least one chiller running?</b> — Displays YES or NO status.</p> <p><b>Chiller(s) running</b> - Displays number of running chillers</p>	<p>R: YES/NO</p>
<p><b>0.1 Plant ON</b> (BNI2) Allows lockout if <b>Lock at value:</b> is checked. Allows communication if <b>Enabled?:</b> is checked.</p>	
<p><b>3. AND Is It Scheduled?</b> — Link to a BACnet Binary Value that indicates the chiller manager (or chiller, if single chiller only) is running. — Displays YES or NO status.</p> <p><b>NOTE</b> Use only a schedule that is coordinated with the chiller plant operation.</p>	<p>R: YES/NO</p>
<p><b>Lock schedule to ON if not desired as a condition:</b></p>	
<p><b>Schedule</b> (BBV) — Displays Off or On status.</p>	<p>R: Off/On</p>
<p><b>4. AND are outdoor air conditions met?</b> — Set the outside air temperature enable conditions to stabilize the program when the weather is warm enough for the chiller plant to stabilize. — Displays YES or NO status.</p>	<p>R: YES/NO</p>
<p><b>__ degrees — Outdoor Air Temperature</b> — Displays current OAT</p>	<p>D: 65 °F</p> <p>R: 50 to 70 °F</p>
<p><b>Allow optimizer to run if OA Temperature &gt; __ degrees.</b></p>	<p>R: Disallow/Allow</p>
<p><b>(with hysteresis of __ degrees)</b></p>	<p>D: 4 °F</p> <p>R: 2 to 5 °F</p>

Point Name/Description	Range
<b>___ optimizer enable if OA Temperature is Invalid.</b>	D: Allow R: Disallow/Allow
<b>Delays</b> <b>Wait __:__(mm:ss) after chiller plant is enabled before checking part load conditions and further enabling optimization.</b> <b>Present output is True for 0:00 (mm:ss)</b> – Displays status.	D: 00:10 (mm:ss) R: 0:00 to 10:00 (mm:ss)
<b>5. AND are Part Load Conditions met?</b> – Set the part load conditions to fit your chiller plant. The program defaults to run when the chiller plant is operating above 20%.  If the reset is applied at very low load conditions, the plant may cycle off more frequently when on low load or low delta temperature. The program starts to cool down to lowest chilled water supply temperature when the load is below the low threshold. – Displays YES or NO status.	R: YES/NO
<b>__% Current load/capacity</b> – Displays value.	R: 0 to 100%
<b>Allow Optimizer Reset if Load is &lt; __% of capacity</b>	D: 90% R: 60 to 90%
<b>hysteresis of __%</b>	D: 5% R: 5 to 10%
<b>6. AND is the Chilled Water Temperature Difference (return-supply) across the chiller evaporator great enough?</b> – Set a minimum allowed temperature across the evaporator so the temperature difference will not drop too low. This prevents the chiller from cycling off on low load too often and helps to stabilize chiller operation. The optimization program will not start until the temperature drop across the evaporator is large enough. – Displays YES or NO status.  <b>Chilled Water Temperature Difference</b> – Displays delta temperature in degrees	
<b>Allow if (Chilled Water Return Temperature - Chilled Water Supply Temperature) is &gt; __ degrees</b>	D: 5 °F R: 3 to 10 °F
<b>with hysteresis of __ degrees</b>	D: 3 °F R: 1 to 5 °F
<b>Delays</b>	
<b>1. Wait __ : __ (mm:ss) before disabling algorithm after plant goes out of part load conditions.</b>  Present output is: True/False for 0:00 (mm:ss) – Displays status.	D: 5:00 (mm:ss) R: 0:00 to 10:00 (mm:ss)
<b>2. Wait __ : __ (mm:ss) after part load conditions are enabled before starting optimization.</b>  Present output is : True/False for 0:00 (mm:ss) – Displays status.	D: 5:00 (mm:ss) R: 0:00 to 10:00 (mm:ss)
<b>3. Pause algorithm when staging up or down:</b> – This encourages algorithm stability.	D: On R: Off/On

Point Name/Description	Range
<p><b>Hold algorithm in current state for __ : __ (mm:ss) after stage up or stage down</b> Present output is : True/False for __ (mm:ss) – Displays status.</p> <p><b>Optimizer pause is __ because of chiller stage up or down.</b> – Displays Off or On status.</p>	<p>D: 20:00 (mm:ss)</p> <p>R: 10:00 to 60:00 (mm:ss)</p>
<b>Loss of Communications Lockout Conditions</b>	
<b>Allow Optimizer Lockout on loss of communications?</b>	<p>D: Off</p> <p>R: Off/On</p>
<b>Loss of Network Communications Conditions</b>	
<p><b>Network communications is considered lost if not valid for _:___ (mm:ss)</b> (output is True/False for _:___ (mm:ss). – Displays status and value.</p> <p>Optimizer <b>IS/IS NOT</b> latched off due to comm loss – Displays status.</p>	<p>D: 5:00 (mm:ss)</p> <p>R: 1 to 10 (mm:ss)</p> <p>R: IS/IS NOT</p>
<b>Latch optimizer operation OFF</b>	
<p><b>1. If the comm is lost for _:___ (mm:ss) or more.</b> Time since loss of comm _:___ (mm:ss) – Displays status.</p>	<p>D: 1:00 (mm:ss)</p> <p>R: 0:00 to 5:00 (mm:ss)</p>
<p><b>2. OR if __ or more comm losses occur</b></p>	<p>D: 3</p> <p>R: 2 to 5</p>
<p><b>within a period of _:___ (mm:ss)</b> <b>Number of comm losses this period __</b> – Displays value. <b>Time since first loss of comm _:___ (mm:ss)</b> – Displays value.</p>	<p>D: 10:00 (mm:ss)</p> <p>R: 0 to 20:000 (mm:ss)</p>
<b>Clear latch out and restore optimizer operation</b>	
<p><b>1. If the comm is restored lost for _:___ (mm:ss) or more.</b> <b>Time since restored comm _:___ (mm:ss)</b> – Displays value.</p>	<p>D: 5:00 (mm:ss)</p> <p>R: 0:00 to 10:00 (mm:ss)</p>
<p><b>2. Or manually reset and clear the latch out and restore operation.</b></p>	<p>D: Off</p> <p>R: Off/Reset and Clear</p>
<b>Alarm(s):</b>	
<b>COMMLOSS (BALM) Loss of Comm Alarm</b> – Displays communication alarm status.	R: Off/On
<p><b>Alarm and stop the optimizer if the Cooling Load, CHW Flow, CHWR Temp or CHWS Temp sensor values indicate sensor is out of range and invalid.</b> <b>Alarm if signal indicates sensor out of range for _:___ (mm:ss)</b></p>	<p>D: 1:00 (mm:ss)</p> <p>R: 0:00 to 4:00 (mm:ss)</p>
<p><b>with output of False for _:___ (mm:ss)?</b></p>	<p>D: YES</p> <p>R: YES/NO</p>
<b>SENSOR (BALM) __ Sensor Out of Range</b> – Displays Off or On status.	R: Off/On

## Section 2 - Chiller System Power, Efficiency, and Thermal Load Input Status

Navigation: i-Vu®

**Properties > Control Program > General Conditions & Status > Section 2 - Chiller System Power, Efficiency and Thermal Load Input Status**

- 1 Verify network connections are operating. See *Device Address Binding* (page 45).
- 2 Input the nominal chiller capacities (tons) required to determine part load conditions.
- 3 Select whether the power input is actual kW or amperage.
- 4 Select load input type using temperatures and flow or cooling load input.
- 5 Enter voltage and power factors from the equipment's specifications.

Point Name/Description	Range
The following are statuses displayed from the linked network points. See <i>Device Address Binding</i> (page 45). <b>Total Chiller kW</b> – Displays value.	
<b>Total Chilled Water Pump kW</b> – Displays value. <b>If "Amp" network inputs are used for CHWP kW determination, then:</b> <b>The voltage is ___ volts</b> – Enter value. <b>The Power Factor is __.</b> – Enter value.	
<b>Total Condenser Water Pump kW</b> – Displays value. <b>If "Amp" network inputs are used for CWP kW determination, then:</b> <b>The voltage is ___ volts</b> – Enter value. <b>The Power Factor is __.</b> – Enter value.	
<b>Total Cooling Tower Fan kW</b> – Displays value. <b>If "Amp" network inputs are used for Cooling Tower Fan kW determination, then:</b> <b>The voltage is ___ volts</b> – Enter value. <b>The Power Factor is __.</b> – Enter value.	
<b>Total Airside Fan kW</b> – Displays value. <b>If "Amp" network inputs are used for AHU VAV Fan kW determination, then:</b> <b>The voltage is ___ volts</b> – Enter value. <b>The Power Factor is __.</b> – Enter value.	
<b>Total System kW (Chillers + CHWPs + CWPs + CTs + Fans)</b> – Displays value.	
<b>Total Building Cooling Load Tons</b> – Displays value.	
<b>Total System kW/ton</b> – Displays value.	

Point Name/Description	Range
<b>CHILLER POWER INPUTS AND CAPACITIES</b>	
<b>Are the Chiller Normal Capacities (below) in Tons or kW? (Default is tons.)</b>	D: tons R: tons/kW
<b>CHILLER 1*</b>	
<b>1 CH1 ON</b> (BNI2) — Displays status. Allows lockout if <b>Lock at value:</b> is checked. Allows communication if <b>Enabled?:</b> is checked.	D: Unlocked (unchecked) R: Enabled (checked)
<b>1 CH1 kW</b> (BAV) — Displays value.	
<b>1 CH1 kW</b> (ANI2) — Displays value. Allows lockout if <b>Lock at value:</b> is checked. Allows communication if <b>Enabled?:</b> is checked.	D: Unlocked (unchecked) R: Enabled (checked)
<b>Is the CH1 power input above in Amps OR kW?</b> (Default is kW.)	D: kW R: Amps/kW
<b>If Amps: The chiller voltage is ___ volts</b> — Enter value <b>If Amps: Power Factor is ___</b> — Enter value	
<b>CH1 Nominal Capacity is: ___ tons</b> — Enter value.	D: 225 R: Chiller capacity
*Continue the same settings as above up to <b>CHILLER 8</b>	
<b>COOLING LOAD, TEMPERATURES &amp; FLOW INPUTS</b>	
<b>13 Cooling Load</b> (ANI2) — Displays value. Allows lockout if <b>Lock at value:</b> is checked. Allows communication if <b>Enabled?:</b> is checked.	D: Unlocked (unchecked) R: Enabled (checked)
<b>Use Cooling Load Input (above) OR use the Temperatures &amp; Flow (below) to calculate the cooling load?</b>	D: Cooling Load Input R: Cooling Load Input Temperatures & Flow
<b>If using the ___</b> — Displays status. <b>Is the Load in Tons OR kW?</b> (Default is tons.) — Enter value.	D: tons R: tons/kW
<b>13 CHWR Temp</b> (ANI2) — Displays value. Allows lockout if <b>Lock at value:</b> is checked. Allows communication if <b>Enabled?:</b> is checked.	D: Unlocked (unchecked) R: Enabled (checked)

Point Name/Description	Range
<p><b>13 CHWS Temp</b> (ANI2) — Displays value.</p> <p>Allows lockout if <b>Lock at value:</b> is checked. Allows communication if <b>Enabled?:</b> is checked.</p>	<p>D: Unlocked (unchecked)</p> <p>R: Enabled (checked)</p>
<p><b>13 CHW FLOW</b> (ANI2) — Displays value.</p> <p>Allows lockout if <b>Lock at value:</b> is checked. Allows communication if <b>Enabled?:</b> is checked.</p>	<p>D: Unlocked (unchecked)</p> <p>R: Enabled (checked)</p>

## Section 3 - Stagger Reset - Enable Conditions

---

Navigation: i-Vu®

**Properties > Control Program > General Conditions and Status > Section 3 - Stagger Reset - Enable conditions**

Stagger Reset is only enabled when both Chilled Water Reset and Condenser Water Reset are running

Stagger Reset alternates between the chilled water reset and the condenser water reset calculations. When on, the program first resets the chilled water supply temperature and calculates its impact on decreasing energy demand. It then resets the condenser water temperature and calculates its impact on decreasing energy demand. This is a lead-lag approach.

If both chilled water and condenser water optimizer reset calculations are done simultaneously, the program would not know whether the chilled water reset alone decreased energy demand, or the condenser water reset decreased energy demand. Temperatures might be reset in the wrong direction.

Point Name/Description	Range
<p><b>Lead / Lag - Stagger routine for optimization is: __</b> — Displays On/Off status.</p>	<p>D: On</p>
<p><b>Condenser Water Optimization Reset is now ___ in the stagger routine.</b> — Displays Held off or Running status.</p>	<p>R: Off/On</p>
<p><b>Chilled Water Optimization Reset is now ___ in the stagger routine.</b> — Displays Held off or Running status.</p>	



## Section 4 - Optimizer Setpoint Change Mode

Navigation: i-Vu®

**Properties > Control Program > General Conditions & Status > Section 4 - Optimizer Setpoint Change Mode**

**Optimizer Setpoint Change Mode** determines if the optimizer resets the setpoints automatically or requires manual intervention and entry. The default is **AUTOMATIC** mode. During each response period, the optimizer determines a new setpoint that best lowers energy consumption.

Modes:

- **AUTOMATIC** – The optimizer calculates the new setpoint and then automatically changes it. It repeats every response period. No operator is required.
- **MANUAL** – The optimizer calculates the new setpoint, and requires an operator to change it. It repeats every response period. An operator must continually monitor and change the setpoint.

Each response period, when the optimizer finishes its calculation, the optimizer instructs the operator to change to the new setpoint, which should be changed within 2 minutes after each new setpoint is determined. If the operator delays changing the setpoint, then the optimizer begins losing effectiveness in saving energy.

The optimizer calculates the next setpoint only after the operator changes it. The process repeats itself each response period.

Point Name/Description	Range
<b>Optimizer is In: ___ mode</b> — Select desired mode.	D: AUTOMATIC R: AUTOMATIC MANUAL
<b>Optimizer is in MANUAL mode</b>	
<b>CHILLED WATER SETPOINT - OPTIMIZATION</b>	
<b>Optimizer Status</b> — Displays the following statuses: <ul style="list-style-type: none"> <li>○ <b>PRE-START UP</b> – Optimizer doing pre-start calculations when first initiated</li> <li>○ <b>FIRST RESET</b> – Optimizer ready for first reset</li> <li>○ <b>CALCULATING</b> – Optimizer calculating next setpoint</li> <li>○ <b>NEW SETPOINT</b> – Optimizer has new setpoint and is ready for acceptance</li> <li>○ <b>WAITING TURN</b> – Setpoint calculation in waiting when stagger is ON</li> <li>○ <b>PAUSE IS ON</b> – Displays when pause is ON</li> <li>○ <b>COOL DOWN IS ON</b> – Displays when cool down is ON</li> <li>○ <b>AUTOMATIC</b> – Displays when in AUTOMATIC mode</li> </ul>	R: OFF PRE-START UP FIRST RESET CALCULATING NEW SETPOINT WAITING TURN PAUSE IS ON COOL DOWN IS ON AUTOMATIC
<b>Countdown until “New Setpoint” is determined:</b> — Displays value.	R: (minutes:seconds)
<b>Optimizer Instructions</b> — Displays status.	R: NO ACTION NEEDED WAIT FOR RESULT SETPOINT AVAILABLE
<b>Elapsed time since “New Setpoint” is determined: ___</b> — Displays value.	R: (minutes:seconds)

Point Name/Description	Range
<b>New Setpoint: ___ degrees</b> – Displays value.	R: degrees
<b>Setpoint was changed?</b> – Enter status. <b>NOTE</b> Change setting only when <b>SETPOINT AVAILABLE</b> displays in <b>Operator Instructions:</b> .	D: NO R: NO/YES
<b>Current Optimizer Setpoint: ___ degrees</b> – Displays value.	R: degrees
<b>Current Chiller Setpoint: ___ degrees</b> – Displays value.	R: degrees
<b>CONDENSER WATER SETPOINT - OPTIMIZATION</b>	
<b>Optimizer Status:</b> – Displays status. <ul style="list-style-type: none"> <li>○ <b>PRE-START UP</b> – optimizer doing pre-start calculations when first initiated.</li> <li>○ <b>FIRST RESET</b> – optimizer is ready for first reset.</li> <li>○ <b>CALCULATING</b> – optimizer is calculating next setpoint</li> <li>○ <b>NEW SETPOINT</b> – optimizer has new setpoint and is ready for acceptance.</li> <li>○ <b>WAITING TURN</b> – setpoint calculation is waiting when stagger is ON</li> <li>○ <b>PAUSE IS ON</b> – displays when pause is ON.</li> <li>○ <b>WARM UP IS ON</b> – displays when warm up is ON.</li> <li>○ <b>AUTOMATIC</b> – displays when in AUTOMATIC mode.</li> </ul>	R: OFF PRE-START UP FIRST RESET CALCULATING NEW SETPOINT WAITING TURN PAUSE IS ON WARM UP IS ON AUTOMATIC
<b>Countdown until “New Setpoint” is determined:</b> Displays value	R: (minutes:seconds)
<b>Operator Instructions:</b> – Displays status.	R: NO ACTION NEEDED WAIT FOR RESULT SETPOINT AVAILABLE
<b>Elapsed time since “New Setpoint” is determined: ___</b> – Displays value.	R: (minutes:seconds)
<b>New Setpoint: ___ degrees</b> – Displays value.	R: degrees
<b>Setpoint was changed?</b> – Enter status. <b>NOTE</b> Change setting only when <b>SETPOINT AVAILABLE</b> displays in <b>Operator Instructions:</b> .	D: NO R: NO/YES
<b>Current Optimizer Setpoint: ___ degrees</b> – Displays value.	R: degrees
<b>Current Condenser Setpoint: ___ degrees</b> – Displays value.	R: degrees

## Chilled Water Temperature Optimizer Reset

Navigation: i-Vu®

Properties &gt; Control Program &gt; Chilled Water Temperature Optimizer Reset

Point Name/Description	Range
<b>Optimizer Chilled Water Supply Reset Enable</b> – Displays status.	R: Disabled/Enabled
<b>Optimized Chilled Water Supply Setpoint AV</b> – Displays status.	D: Off
<b>Lock the CHWS temperature setpoint output __</b>	R: Off/On
<b>To __ (Final setpoint, e.g., 44 degrees F)</b>	D: 44 °F
 <b>CAUTION</b> Bypasses optimizer calculations.	R: 40 to 50 °F
<b>16 CHWS STPT TEMP (REMOTE INPUT)</b> – Displays value. Allows lockout if <b>Lock at value:</b> is checked. Allows communication if <b>Enabled?:</b> is checked.	D: Unlocked (checked) D: Enabled (checked)
<b>16 CHWS TEMP (REMOTE INPUT)</b> – Displays value. Allows lockout if <b>Lock at value:</b> is checked. Allows communication if <b>Enabled?:</b> is checked.	D: Unlocked (checked) D: Enabled (checked)
<b>CHWR RETURN TEMP</b> – Displays value.	
<b>Total Chiller kW/ton</b> – Displays value.	
<b>Total Chilled Water Pump kW/ton</b> – Displays value.	
<b>Total Airside Fan kW/ton</b> – Displays value.	
<b>Total Chilled Water System kW/ton</b> – Displays value.	
<b>16 Optimized CHWS Reset Heartbeat ANO Minutes</b> – Displays value. Allows lockout if <b>Lock at value:</b> is checked. Allows communication if <b>Enabled?:</b> is checked.	D: Unlocked (unchecked) D: Enabled (checked)
<b>16 Optimized CHWS Setpoint ANO</b> – Displays value. Allows lockout if <b>Lock at value:</b> is checked. Allows communication if <b>Enabled?:</b> is checked.	D: Unlocked (unchecked) D: Enabled (checked)

## Section 1 - Chilled Water System Optimizer - Enable conditions

---

Navigation: i-Vu®

**Properties > Control Program > Chilled Water Temperature Optimizer Reset > Section 1 - Chilled Water System Optimizer - Enable Conditions**

	Point Name/Description	Range
	<p><b>1. CHWS Optimizer ON Switch:</b> – Displays Disabled/Enabled status.</p>  <b>CAUTIONS</b> <ul style="list-style-type: none"> <li>You must set this to <b>DISABLED</b> until the system is set up and ready to run.</li> <li>The <b>Main ON Switch</b> in <i>Section 1 - Optimizer - Primary Enable Conditions</i> (page 60) must also be enabled for the CHWS Optimizer to be enabled.</li> </ul>	<p>D:     DISABLED</p> <p>R:     DISABLED/ENABLED</p>

## Section 2 - Automatic Overrides of Chilled Water Reset

---

Navigation: i-Vu®

**Properties > Control Program > Chilled Water Temperature Optimizer Reset > Section2 - Automatic Overrides of Chilled Water Reset**

The chilled water reset is automatically overridden by:

- Automatic "Pause & Hold"
- Automatic "Quick Cool Down"

You must configure the following properties to balance chiller stability.

### **Automatic "Pause & Hold"**

In **Automatic "Pause & Hold"**, the reset pauses its operation and holds the supply temperature at its current setpoint under any one of the 3 following conditions:

#### **1 The chilled water return temperature gets too cold.**

This indicates a low load condition, or low temperature difference across the air handling unit cooling coils, which could cause the chiller to cycle off. The chiller could be held on longer and operate under more stable conditions, if the supply temperature is not reset any higher. Input the preferred low temperature trip point and the delay that best fits your system.

#### **2 The temperature difference across the evaporator gets too cold.**

This can happen as the chilled water supply temperature rises faster than the chilled water return temperature. This could create low load conditions across the chiller and could cycle off too often. The chiller could stay on longer if the chilled water is not reset any higher. This allows time for the return water temperature to rise, and the load across the chiller to remain high enough for it to continue to run. Input the preferred low temperature trip point and delay that best fits your system.

#### **3 The building relative humidity gets too high.**

The program has the option to monitor relative humidity (up to 20 sensors) throughout the building. If the user-configurable average or maximum RH rises above a predefined threshold, the program holds its chilled water reset. If the humidity continues to rise, then the program lowers the chilled water supply temperature setpoint as described below.

#### **4 The thermal load gets too high.**

The program has the option to pause if the thermal load to capacity rises above a certain threshold. If the thermal load to capacity rises above a predefined threshold (in percentage), the program holds its chilled water reset. If it continues to rise, then the program lowers the chilled water supply temperature setpoint as described below.

#### **5 The remote pause is enabled.**

The program has the option to pause if there is a remote BACnet pause signal. If the remote pause input is enabled, the program holds its chilled water reset.

## Automatic "Quick Cool Down"

Configure the **Automatic "Quick Cool Down"** function for the chilled water reset to enable the optimization program to balance comfort with energy savings. When in automatic cool down, the chilled water optimization reset overrides its operation and drops the supply temperature under any one of the 5 following conditions:

### 1 The building is too warm and the incoming cooling requests rise above threshold

When this happens, the optimization program is overridden and the chilled water temperature resets downward by a predetermined adjustable rate until the building cools down and no longer needs cooling. Input your preferred threshold number of requests, that are needed before cool down occurs, and delay.

### 2 The chilled water return temperature gets too warm

The chilled water return temperature can act as an indicator of the facility warming up and exceeding occupant comfort. Input your preferred high chilled water return temperature trip point that is needed before cool down occurs, and delay.

### 3 The temperature difference across the evaporator gets too cold

Like Automatic Pause, the chiller could stay on longer if the load across the chiller remains high enough for it to continue to run. If the temperature difference drops below the pause threshold, then you may want to actually lower the chilled water supply temperature to increase the load. Dropping the chilled water supply temperature raises the temperature difference and encourages chiller stability. Input your preferred low temperature trip point and delay.

**NOTE** This low temperature trip point should be below the pause trip point since the pause is the first step in preventing excessive cycling. If the temperature drops below the pause trip point, then lowering the temperature would be the second step.

### 4 The building relative humidity rises above a threshold (user-configurable)

Like Automatic Pause, this is a response to rising humidity levels. The Automatic Pause is the first step and, if the humidity levels continue to rise, the second step is lowering the chilled water supply temperature. The setpoint continues to drop each response interval until the relative humidity conditions drop to an acceptable level.

### 5 The chilled water temperature setpoint rises above a predefined high limit

This is another measure to prevent high humidity conditions, especially when you have chilled beams and the dewpoint is a problem. Enter the high chilled water supply setpoint limit and the setpoint drops if the limit is exceeded.

### 6 IF the "Remote Quick Cool Down" BBV receives a binary ON signal

This is for those systems which, for any reason, need to cool down the supply temperature. It is activated by a remote BACnet binary write signal.

During automatic cool down, the temperature drops immediately by the cool down temperature increment (which you define in **Quick Cool Down Incremental drop**, Section 3 - Manual Overrides of Chilled Water Resets), and then the program cools down by the same amount each Response Period.

In conditions above, you may select to cool down more quickly, as an **"Emergency Cool Down"**, rather than the **"Quick Cool Down"** settings in Section 3 Manual Overrides of Chilled Water Reset - and other Settings. If so, you may configure **"Emergency Cool Down Incremental Drop"** settings in this section.

Point Name/Description	Range
<b>Automatic "Pause &amp; Hold" Override of the Optimizer Reset &amp; Pause at its Current Reset Setpoint</b>	
1. <b>Pause Reset If CHWRT Is &gt;__ degrees</b>	D: 46 °F R: 45 to 50 °F
<b>with hysteresis of __</b>	D: 1 °F R: 1 to 3 °F
<b>for __:__(mm:ss)</b> Present output is False for __:__(mm:ss). – Displays value.	D: 4:00 (mm:ss) R: 2:00 to 10:00 (mm:ss)
2. <b>OR Pause Reset If CHWRT-CHWST is &lt;__degrees</b>	D: 6 °F R: 2 to 7 °F
<b>with hysteresis of __</b>	D: 1 °F R: 1 to 3 °F
<b>for __:__(mm:ss)</b> Present output is False for __:__(mm:ss). – Displays value.	D: 4:00 (mm:ss) R: 2:00 to 10:00 (mm:ss)
3. <b>OR Pause Reset If Building Relative Humidity is &gt; __%</b>	D: 60% R: 50 to 100%
<b>with hysteresis of __</b>	D: 2% R: 2 to 10%
<b>for __:__(mm:ss)</b> Present output is False for __:__(mm:ss). – Displays value.	D: 20:00 (mm:ss) R: 10:00 to 60:00 (mm:ss)
<b>Use the __ building relative humidity from networked sensor values to determine if it is too high.</b> Current Building Relative Humidity is __. __% – Displays value.	D: Average R: Average/Maximum
4. <b>OR Pause Reset If Load is &gt; __% capacity</b>	D: 90% R: 70 to 100%
<b>with hysteresis of __%</b>	D: 5% R: 2 to 10%
<b>__(Pause is default, Algorithm will Cool Down otherwise)</b>	D: Pause R: Pause/Cool Down
5. <b>OR Pause Reset, for a remote condition, if the "Remote Pause" BBV receives a binary ON signal</b>	D: 60% R: 50 to 100%
<b>for __:__(mm:ss)</b> Present output is False for __:__(mm:ss). – Displays value.	D: 20:00 (mm:ss) R: 10:00 to 60:00 (mm:ss)
<b>Automatic Pause &amp; Hold of Chilled Water Reset - Status</b>	

Point Name/Description	Range
<b>Pause &amp; Hold Is: OFF</b> – Displays status.	
<b>Pause &amp; Hold Criteria</b> – Displays statuses and values.	
<b>Automatic "Quick Cool Down" - Override of the Optimizer Reset &amp; Lower the Supply Temperature Setpoint</b>	
<b>1. Drop chws temperature if building gets too warm due to increasing requests for cooling</b> <b>In the Occupied Mode: Drop chws temperature if more than __ cooling requests</b>	D: 3
<b>hysteresis __, are received</b>	D: 1
<b>In the Unoccupied Mode: Drop chws temperature if more than __ cooling requests</b>	D: 6
<b>hysteresis __, are received</b>	D: 1
<b>for __:__(mm:ss)</b> Present output is False for __:__(mm:ss). – Displays value.	D: 1:00 (mm:ss) R: 1:00 to 3:00 (mm:ss)
<b>Building Occupancy Status: __ Mode</b> – Displays status. <b>Total Cool Request: __</b> – Displays value.	
<b>2. OR Drop chws temperature if chilled water return temperature is &gt; __ degrees</b>	D: 58 °F R: 54 to 60 °F
<b>with a hysteresis of __</b>	D: 2 °F R: 1 to 3 °F
<b>for __:__(mm:ss)</b> Present output is False for __:__(mm:ss). – Displays value.	D: 8:00 (mm:ss) R: 1:00 to 10:00 (mm:ss)
<b>3. OR Drop chws temperature if chilled water return - supply temperature is &lt; __ degrees</b>	D: 5 °F R: 5 to 8 °F
<b>with a hysteresis of __</b>	D: 0.5 °F R: 0.25 to 1 °F
<b>for __:__(mm:ss)</b> Present output is False for __:__(mm:ss). – Displays value.	D: 8:00 (mm:ss) R: 1:00 to 10:00 (mm:ss)
<b>4. OR Drop chws temperature if building relative humidity is &gt; __%</b>	D: 65% R: 50 to 100%
<b>with a hysteresis of __</b>	D: 2% R: 2 to 10%
<b>for __:__(mm:ss)</b> Present output is False for __:__(mm:ss). – Displays value. <b>Current Building Relative Humidity is __%</b> – Displays value.	D: 20:00 (mm:ss) R: 10:00 to 60:00 (mm:ss)



Point Name/Description	Range
<b>5. OR Drop chws temperature for humidity &amp; dewpoint control, if chws setpoint rises above __ degrees</b> – Displays value.	
<b>with a hysteresis of __</b>	D: 2 °F
<b>High CHWS Setpoint Limit for RH Control __ °F</b> – Displays value. <b>Default Value: __</b>	D: 70 °F R: 50 to 70 °F
<b>Lock at value __</b>	D: Unlocked (unchecked)
<b>6. OR Drop chws temperature, for a remote condition, if the "Remote Quick Cool Down" BBV receives a binary ON signal</b>	
<b>for __:__(mm:ss)</b> Present output is False for __:__(mm:ss). – Displays value.	D: 8:00 (mm:ss) R: 3:00 to 60:00 (mm:ss)
<b>Remote Quick Cool Down (BBV)</b> – Displays value. <b>Default Value: __</b>	D: Off R: Off/On
<b>Lock at value __</b>	D: Unlocked (unchecked)
<b>"Emergency Cool Down Response" Time In Minutes (3=min to 30=max): __ minutes</b> <b>Current interval time is __ minutes and __ seconds</b> – Displays values.	
<b>Use "Emergency Cool Down Response" Time? __</b> <b>NOTE</b> You can use this instead of the default "System Response Time" of __ minutes, set in Section 3.	D: No R: No/Yes
<b>Emergency Cool Down Incremental Drop __ (deg)</b> - Drop per Response Interval	D: 1.5 R: 1 to 4
<b>Use "Emergency Cool Down Incremental Drop"? __</b> <b>NOTE</b> You can use this instead of the default "Quick Cool Down Incremental Drop" of __ (deg) per response interval, set in Section 3. – Displays value.	D: No R: No/Yes
<b>Automatic Quick Cool Down of Chilled Water Supply - Status:</b>	
<b>Quick Cool Down is: __</b> – Displays OFF/ON status.	
<b>Quick Cool Down Criteria:</b> – Displays statuses and values.	
<b>Chilled Water Temperature Alarms</b>	
<b>Alarm(s):</b>	D: 30 (mm:ss)
<b>Enable Chilled Water Temperature alarms after the optimizer has been enabled for __:__ mm:ss</b>	R: 10:00 to 60:00 (mm:ss)
<b>CHRT HI (BALM) __</b> – Displays status. <b>Alarm if chilled water return temperature is &gt; __ degrees</b>	D: 62 °F R: 50 to 70 °F
<b>hysteresis of __</b>	D: 2 °F R: 0.5 to 3 °F

Point Name/Description	Range
<p><b>for __:__(mm:ss)</b> Present output is False for __:__(mm:ss). – Displays value.</p>	<p>D: 10:00 (mm:ss) R: 2:00 to 20:00 (mm:ss)</p>
<p><b>CHDT LO (BALM) ___</b> – Displays status. <b>Alarm If (chilled water return - supply temperature) is &gt; __ degrees</b></p>	<p>D: 4 °F R: 3 to 8 °F</p>
<p><b>hysteresis of __</b></p>	<p>D: 2 °F R: 0.5 to 3 °F</p>
<p><b>for __:__(mm:ss)</b> Present output is False for __:__(mm:ss). – Displays value.</p>	<p>D: 10:00 (mm:ss) R: 2:00 to 20:00 (mm:ss)</p>

### Section 3 - Manual Overrides of Chilled Water Reset - and other Settings

Navigation: i-Vu®

**Properties > Control Program > Chilled Water Temperature Optimizer Reset > Section 3 - Manual Overrides of Chilled Water Reset - and other Settings**

The program outputs a reset signal in the range of 0 - 10 (deg). This reset signal is not the actual temperature reset, because the 0-10 (deg) reset is ultimately converted to a signal used by the equipment.

**NOTE** The (deg) designation does not indicate actual degrees, but the 0-10 output range of the algorithm that is converted into an actual temperature

**EXAMPLE** The 0 - 10 (deg) reset range might be converted to 42 - 50 °F reset signal used for a chilled supply temperature setpoint. Therefore, the 0 - 10 (deg) reset signal is converted to a range of 0 - 8 °F. Each reset increment of 1 (deg) would actually be a 0.8 °F increment.

Reset settings such as **First Reset, Full Load Drop, Quick Cool Down**, and any other temperature reset settings, are always based on 0 - 10 (deg) program output, not the final output.

Point Name/Description	Range
<p><b>Manual "Reinitialize" &amp; "Pause &amp; Hold" - Override of the Optimizer Reset &amp; Pause at It Current Reset Setpoint</b></p>	
<p><b>Reinitialize CHWS reset algorithm (resets algorithm logic to zero):</b> To manually reinitialize and reset the chilled water optimization, turn on by selecting <b>REINITIALIZE</b>. After a few moments, this returns the program back to its initial zero state. Turn the reinitialize switch to <b>Off</b> to allow the program to operate again from its zero state.</p> <p> <b>CAUTION</b> This setting drops the setpoint back to its default temperature and restarts the program from state zero.</p>	<p>D: Off R: Off/REINITIALIZE</p>

Point Name/Description	Range
<b>Pause CHWS reset algorithm (holds logic at current state and output):</b> — To manually pause the chilled water supply, select <b>PAUSE</b> . When you no longer need the pause, select <b>OFF</b> and the application begins again from its holding pattern.	D: Off R: Off/PAUSE
<b>Pause &amp; Hold Is:___</b> — Displays OFF or ON status..	R: OFF/ON
<b>Alarm if the "Pause CHWS reset algorithm" above is on longer than _:_(mm:ss)</b>	D: 30:00 (mm:ss) R: 10:00 to 60:00 (mm:ss)
<b>with output of ___ for _:_(mm:ss)</b> — Displays status and value.	
<b>CHW MAN PAUSE ALARM (BALM) __</b> — Displays Off or On status.	
<b>Manual "Quick Cool Down" - Override of the Optimizer Reset &amp; Lower the Supply Temperature Setpoint</b>	
<b>Quick Cool Down (lowers chws temperature):</b> — A manual override to drop chilled water supply temperature.  This is a manual cool down of the chilled water supply temperature used to override the chilled water optimization and to cool down the facility. Turn the switch to <b>Quick Cool Down</b> and the temperature drops immediately by the cool down temperature increment (defined below), and then the temperature cools down by the same amount each <b>Response Time</b> (set in the following section).  The cool down continues until minimum reset is reached. To turn off <b>Quick Cool Down</b> , select <b>Off</b> and the program begins again, starting from the current reset temperature.	D: Off R: Off/QUICK COOL
<b>Quick Cool Down incremental drop: __ (deg) - Drop per Response Interval</b> — This is the incremental amount the chilled water supply temperature is dropped (initially and each response period) when in <b>Quick Cool Down</b> . Input your desired amount and its response time.  This incremental drop also applies to:  Automatic cool down described in <i>Section 2 - Automatic Overrides of Chilled Water Resets</i> (page 70)  Cool down to default low temperature when not in part load conditions described as Step 5 in <i>Section 1 - Optimizer - Primary Enable Conditions</i> (page 60)	D: 1 (deg) R: 0.5 to 2 (deg)
<b>Quick Cool Down Is: __</b> — Displays OFF or ON status.	
<b>First Reset</b>	
<b>First Reset - Raise Temperature Initially by: __(deg)</b> — The first reset should be large enough for the system to register the reset temperature and respond to it, but not so large that it creates instability. If the temperature increment is too small, then the system won't experience enough temperature change to determine if it saves energy.  The program measures the decrease (or possible increase) in kW/ton from this first reset. It then determines what the next reset should be.  We recommend no more than 2 (deg), though it can be a maximum of 4 (deg).	D: 1.25 (deg) R: 0.7 to 2.0 (deg)

Point Name/Description	Range
<p><b>Allow 50% of previous day's average reset as a first increment?</b> — The program keeps a running average of the previous day's reset values. This value can be used as a first reset, which is closer to the optimal reset temperature for the most efficient operation.</p> <p>However, this calculated value is limited to 4 °F. Even though the average temperature of the most efficient operation is close to the same on subsequent days, it may not always be the most efficient temperature at the beginning of the day.</p> <p>If set to <b>ON</b>, the program takes the highest of <b>First Reset</b> (configured above) or <b>Previous day's average reset</b>.</p>	<p>D: Off</p> <p>R: Off/On</p>
<b>Input Smoothing and System Response Time</b>	
<p><b>Input Smoothing (0=min : 100=max):</b></p> <p>This setting "smooths" the (kW/Ton) input and removes erratic signals.</p> <p>This smoothing is more complex and subtle than most. It does not smooth the signal excessively and it adjusts without shifting the output too much.</p> <p>Input settings:</p> <p>0 - no smoothing</p> <p>1 - automatic minimal smoothing</p> <p>Up to 100 (maximum smoothing or dampening)</p>	<p>D: 50</p> <p>R: 0 to 100</p>
<p><b>System Response time in minutes (3=min to 30=max): __ minutes</b></p> <p>Current interval time is: __minutes and __. __ seconds. — Displays values.</p> <p> <b>CAUTION</b> Critical setting.</p> <p>This setting defines the time it takes for the chilled water system to respond after the optimization program resets the temperature. The program needs to know if the system is using less energy after the setpoint has changed and after the system has settled to the new setpoint.</p> <p>The following must occur at the completion of one response time period:</p> <p>Chiller supply temperature reaches the new setpoint temperature</p> <p>Pumps reach their new speed in response to valves opening</p> <p>Air handling unit valves open (or close) based on new chilled water temperature (if applicable)</p> <p>Air handler supply air temperature reaches steady state value</p> <p>Air handling unit fan speeds up or slows down, due to supply air temperature change (VAV systems)</p> <p>The response time is difficult to approximate. You will need to initially monitor the entire system to determine when the above conditions have been achieved. Start with the 20 minute default value and adjust as required based on the actual system response.</p>	<p>D: 15 minutes</p> <p>R: 3 to 30 minutes</p>

Point Name/Description	Range
<p><b>Minimum and Maximum Reset Increments &amp; Program Reset Gain</b></p> <p>Each response period, the program determines the next reset signal that lowers energy demand most effectively. The program outputs a reset signal between 0 and 10 (deg) (0 (deg) is no reset or coolest temperature, 10 (deg) is the maximum or warmest temperature).</p> <p><b>EXAMPLE</b> The program is producing a 5.4 (deg) reset signal. The next time it resets, in order to minimize energy use, it either adds to the signal, by raising the temperature, or subtracts from the signal, by lowering the temperature. Each reset increment falls between the minimum and maximum allowed reset increment.</p> <p>The actual reset value is based on the reset gains and program measurements of the curve profile. If the program is currently producing a 5.4 (deg) reset, and the next reset increment is determined to be 1.1(deg), then the next reset output will be (5.4 (deg) +1.1 (deg)) = 6.5 (deg). This will be converted to the actual setpoint in the chiller program.</p> <p><b>NOTE</b> The reset increment should be large enough for the system to register the reset temperature and react to it – but not so large that it creates instability. If the temperature increment is too small, the system won't experience enough temperature change to determine if it saves energy.</p>	
<p><b>Minimum Reset Increment: __ (deg) (output units: 0-10)</b> – The minimum allowed output increment for each response interval.</p> <p><b>EXAMPLE</b> If you set this value to 1.0 (deg), the program resets no less than that for each increment. This does not necessarily equal the actual reset at the chiller, which may have a range of 42 to 54 °F. Unless the 0 - 10 (deg) signal is exactly the 10 °F temperature range, the minimum increment may not equal the actual temperature increment. With a range of 42 to 54 °F, each reset degree is (54 - 42 °F)/10 = 1.2 °F.</p>	<p>D: 1 (deg) R: 0.5 to 1.2 (deg)</p>
<p><b>Current reset increment is: __</b> – Displays value.</p>	
<p><b>Maximum Reset Increment: __ (deg) (output units)</b> – The maximum allowed output increment for each response interval.</p> <p><b>EXAMPLE</b> If you set it to 1.5 (deg), the program resets no more than 1.5 (deg) for each increment. As described above, this does not necessarily equate to the actual reset at the chiller.</p>	<p>D: 2 (deg) R: 1.5 to 2.5 (deg)</p>
<p><b>Reset Increment Coarse Gain – (1=min to 10=max)</b> Determines how large each reset increment will be. The program applies the gain to various measurements of the efficiency curve, and determines the next increment size. The larger the gain, the larger the increment. However, no matter how small or large the gain, the increment can be no less than the minimum increment and no more than the maximum increment.</p>	<p>D: 5 R: 1 to 10</p>
<p><b>Reset Increment Fine Gain – (0=min to 10=max)</b> A fine gain that is added to each increment. It can be combined with the above gain to configure the best gain applied to each increment.</p> <p>More is described about how to set up the gain in the <i>Start-up and Commissioning</i> (page 31) section.</p>	<p>D: 0 R: 0 to 10</p>

Point Name/Description	Range
<p><b>Bias for reset of CHWS temperature setpoint for warmer temperatures</b></p> <p>The program works as intended without applying bias. However, there are times that the kW/ton input can be erratic. Adding bias toward warmer temperatures promotes energy savings at the chiller, even though the chilled water reset temperatures are not necessarily the most effective supply temperature for the system.</p> <p><b>EXAMPLE</b> The program is very close to resetting toward a warmer temperature, but not close enough, and still wants to reset for cooler temperatures. This bias shifts the decision slightly toward resetting for warmer temperatures. Energy savings are biased toward the chiller rather than the towers.</p> <p><b>NOTE</b> Bias is not required.</p>	
<p><b>Add a small bias for reset toward warmer CHWS temps?</b> – Turn On for a bias for warmer temperatures.</p>	<p>D: Off R: Off/On</p>
<p><b>Add an additional small bias for reset toward warmer CHWS temps?</b> – This adds a fine adjustment to the small bias (above). Turn <b>On</b> to increase bias for warmer CHWS temperatures and adjust the gain between 0 and 10.</p>	<p>D: Off R: Off/On</p>
<p><b>Fine gain for bias for reset toward warmer CHWS temps (0=min to 10=max)</b> – This adds another fine adjustment to the small bias above, increases bias for warmer temperatures, and adjusts the gain between 0 and 10.</p>	<p>D: 5 R: 0 to 10</p>
<p><b>Reset Output</b></p> <p>Expected chilled water supply setpoint temperature. The programmed "0 - 10 (deg)" output is converted to the chilled water temperature setpoint signal compatible with your system, feeding directly to the chiller setpoint adjust, either in your chiller manager or each chiller program.</p> <p>The chiller setpoint adjust requires an actual temperature range, such as 42 to 52 °F.</p> <p>If the chiller setpoint adjust requires a 0 - 10 input signal, then you must still convert the above (i.e. 42 to 52 °F) to a 0 - 10 signal in the chiller manager or each chiller program. This is not done in the optimization program.</p>	
<p><b>Vary chilled water supply temperature from __ degrees</b> – Defines the minimum allowable chilled water temperature</p>	<p>D: 42 °F R: 42 to 46 °F</p>
<p><b>to __ degrees.</b> Defines the maximum allowable chilled water temperature</p>	<p>D: 52 °F R: 48 to 54 °F</p>
<p><b>Current Setpoint Input</b></p>	
<p><b>Use the current chilled water setpoint (CURR STPT IN) as the optimizer's starting setpoint?</b> – The optimizer's beginning setpoint when first enabled.</p>	<p>D: NO R: NO/YES</p>
<p><b>16 CURR STPT IN (ANI2)</b> – Displays value. Allows lockout if <b>Lock at value:</b> is checked. Allows communication if <b>Enabled?:</b> is checked.</p>	<p>D: Unlocked (unchecked) R: Unlocked (unchecked) Locked (checked)</p>

## Condenser Water Temperature Optimizer Reset

Navigation: i-Vu®

**Properties > Control Program > Condenser Water Temperature Optimizer Reset**

### Overall operation

Like the Chilled Water Temperature Optimizer Reset section, the condenser water reset searches for the condenser water supply temperature that best lowers the kW/ton on the condenser water side. The reset lowers condenser water supply temperature for the approach temperature that balances energy savings at the chiller with energy increases at the tower fans and condenser water pumps.

### Approach temperature

The approach temperature is the difference between condenser water supply temperature and current wet bulb temperature (cws temp – oa wb). The rated approach temperature equates to the lowest condenser water temperature that the tower is likely to produce. A 7 °F approach rating is common for most cooling towers, although more efficient towers can go down to a 5 °F degree approach, or less, in a few cases.

### Condenser water reset function

After the program is enabled, the algorithm begins its optimizing routine with **Section 2 - Manual Overrides of Condenser Water Reset - and other Settings** (page 83) > **First Reset**. Each response period, the program determines the next reset signal that best lowers energy demand. The 0-10 (deg) output is converted to a condenser water supply approach to wet-bulb temperature, which is a setpoint between the maximum and minimum approach. Since the wet bulb temperature varies during the day, the actual condenser water supply setpoint also varies within the approach window (maximum approach – minimum approach). See example setpoint chart below (assuming a very efficient tower with a minimum 5 degree approach).

No Reset of 0	= 12 degree (max approach, adj.)	Warmer Condenser Supply Temp
Full Reset of 10	= 5 degree (min approach, adj.)	Cooler Condenser Supply Temp

**EXAMPLE** The current outside air wet-bulb temperature is 70 °F.

- The program calculates an optimal approach setpoint of 6 °F.

The condenser water setpoint will be  $70^{\circ} + 6^{\circ} = 76^{\circ}\text{F}$  (based on current wet bulb)

If the tower is rated at a 7°F approach, then this is a cooler approach temperature with tower fans likely running at or near 100%. But the chiller would experience lower lift and possibly greater energy savings at such a low approach temperature.

- The program attempts to find the balance of energy saved at the chiller and energy expended at the fans through a calculated approach temperature. So the approach temperature setpoint would likely change throughout the day in a constant search for the optimal temperature.

Point Name/Description	Range
<p>You can use one of the following to link to the tower or pump condenser water setpoint control.</p> <ul style="list-style-type: none"> <li>BACnet ANO2, which writes to a remote Setpoint Analog Value</li> <li>BACnet Analog value, which is read by a remote Setpoint ANI</li> </ul> <p><b>NOTE</b> If using a BAV, link the <b>Optimized (Final) CWS Reset Setpoint</b> BAV to the remote cooling tower logic reset BACnet Analog Input. This output is a temperature setpoint signal and when fed through the condenser water logic, should override the current CWS temperature setpoint.</p> <p>The BACnet Analog Input should go through its own safeties and ramps before setting the CWS temperature setpoint.</p> <p>The Heartbeat may be used to communicate a healthy signal to the receiving program. Use if required or desired, but not necessary.</p>	
<b>Optimizer Condenser Water Supply Reset Enable</b> — Displays status.	R: DISABLED / ENABLED
<b>Optimized Condenser Water Supply Setpoint AV (wetb + approach)</b> (BAV) — Displays value.	
<b>Lock the CWS temperature setpoint output</b> — Locks above setpoint to a specific value.	D: Off R: Off/On
<b>To __ degrees (realistic condenser water supply temperature setpoint)</b> <b>NOTE</b> Bypasses optimizer calculations - but not lower and upper limits. Use with caution.	D: 0 °F R: 70 to 80 °F
<b>Outdoor Air Wet Bulb Temperature</b> — Displays value.	
<b>Optimized Condenser Water Supply Setpoint (calculated approach)</b> (BAV) — Displays value.	
<b>17 CWS STPT TEMP (REMOTE INPUT)</b> — Displays value. Allows lockout if <b>Lock at value:</b> is checked. Allows communication if <b>Enabled?:</b> is checked.	D: Unlocked (unchecked) D: Enabled (checked)
<b>17 CWS TEMP (REMOTE INPUT)</b> — Displays value. Allows lockout if <b>Lock at value:</b> is checked. Allows communication if <b>Enabled?:</b> is checked.	D: Unlocked (unchecked) D: Enabled (checked)
<b>17 CWR TEMP (REMOTE INPUT)</b> — Displays value. Allows lockout if <b>Lock at value:</b> is checked. Allows communication if <b>Enabled?:</b> is checked.	D: Unlocked (unchecked) D: Enabled (checked)
<b>17 CW TEMP (REMOTE INPUT)</b> — Displays value. Allows lockout if <b>Lock at value:</b> is checked. Allows communication if <b>Enabled?:</b> is checked.	D: Unlocked (unchecked) D: Enabled (checked)
<b>Total Chiller kW/ton</b> — Displays value.	
<b>Total Condenser Water Pump kW/ton</b> — Displays value.	



Point Name/Description	Range
<b>Total Cooling Tower Fan kW/ton</b> – Displays value.	
<b>Total Condenser Water System kW/ton</b> – Displays value.	
<b>17 Optimized CWS Setpoint Heartbeat ANO Minutes</b> – Displays value. Allows lockout if <b>Lock at value:</b> is checked. Allows communication if <b>Enabled?:</b> is checked.	D: Unlocked (unchecked) D: Enabled (checked)
<b>17 Optimized CWS Setpoint ANO</b> – Displays value. Allows lockout if <b>Lock at value:</b> is checked. Allows communication if <b>Enabled?:</b> is checked.	D: Unlocked (unchecked) D: Enabled (checked)

## Section 1 - Condenser Water System Optimizer - Enable Conditions

Navigation: i-Vu®

**Properties > Control Program > Condenser Water Temperature Optimizer Reset > Section 1 - Condenser Water System Optimizer - Enable Conditions**

Point Name/Description	Range
<b>1. CWS Optimizer ON Switch:</b> You must set this to <b>DISABLED</b> until the system is setup and ready to run. This enables the <b>Condenser Water Supply Temperature Setpoint Reset</b> portion of the program. <b>NOTE</b> Only turn the set to <b>ENABLED</b> after the program is setup and ready to run. The <b>Main ON Switch</b> in <i>Section 1 - Optimizer - Primary Enable Conditions</i> (page 60) must also be enabled for the CWS Optimizer to be enabled.	D: DISABLED R: DISABLED/ENABLED

## Section 2 - Manual Overrides of Condenser Water Reset - and other Settings

Navigation: i-Vu®

Properties > Control Program > Condenser Water Temperature Optimizer Reset > Section 2 - Manual Overrides of Condenser Water Reset - and other Settings

Point Name/Description	Range
<b>Manual "Reinitialize" &amp; "Pause &amp; Hold" - Override of the Optimizer Reset &amp; Pause at it Current Reset Setpoint</b>	
<p><b>Reinitialize CWS reset algorithm (resets algorithm logic to zero):</b></p> <p>Select <b>REINITIALIZE</b> to manually reinitialize and reset the condenser water optimization. After a few moments, the program returns back to its initial zero state.</p> <p>Select <b>Off</b> to allow the program to operate again from its zero state.</p> <p> <b>CAUTION</b> This setting drops the setpoint back to its default "resting" temperature and restarts the program from state zero.</p>	<p>D: Off</p> <p>R: Off/REINITIALIZE</p>
<p><b>Pause CWS reset algorithm (holds logic at current state and output):</b></p> <p>Select <b>PAUSE</b> to manually pause the condenser water supply reset. When you no longer need the pause, select <b>OFF</b> to begin the program from its holding pattern.</p> <p><b>Pause &amp; Hold is</b> __ – Displays status.</p> <p><b>Pause is</b> __ <b>due to low limit.</b> – Displays status.</p>	<p>D: Off</p> <p>R: Off/Pause</p>
<p><b>Alarm if the "Pause CWS reset algorithm" above is on longer than</b> _:_ (mm:ss)</p>	<p>D: 30:00 mm:ss</p> <p>R: 10:00 to 60:00 mm:ss</p>
<p><b>with output of</b> ____ <b>for</b> _:_ (mm:ss) – Displays status and value.</p>	
<p><b>CW MAN PAUSE ALARM</b> __ – Displays status.</p>	
<b>Manual "Quick Warm Up" - Override of the Optimizer Reset &amp; Raise the Supply Temperature Setpoint</b>	
When on, the setpoint is still limited to its high and low limit settings.	
<p><b>Optimizer CWS Temp - Quick Warm Up:</b> – Manual override to the program to raise condenser water supply temperature.</p>	<p>D: Off</p> <p>R: Off / QUICK WARM</p>
<p><b>Quick Warm Up Incremental rise</b> __ (deg) – Rise per Response Interval</p> <p><b>NOTE</b> The Quick Warm Up (deg) rise applies to warm up when condenser water temperature is considered too cold and a limit is imposed.</p> <p><b>Quick Warm Up Is:</b> – Displays status.</p> <p><b>Quick Warm up is</b> __ <b>due to CWS temperature below low limit.</b> – Displays status.</p>	<p>D: 0.5 (deg)</p> <p>R: 0.5 to 1.5 (deg)</p>

Point Name/Description	Range
<p><b>First Reset</b></p>	
<p><b>First Reset - Lower Temperature Initially by: ___ (deg)</b> – The program requires a priming reset when it is first turned on. The reset occurs after the program has first been enabled in <b>General Conditions &amp; Status</b> and <b>Section 1 - Optimizer - Primary Enable Conditions</b>.</p> <p>For the condenser water optimization, this determines the initial approach temperature. The first reset, or priming reset, should be large enough for the system to register the reset temperature and respond to it, but not so large that it creates instability. If the temperature increment is too small, then the system won't experience enough temperature change to determine if it saves energy.</p> <p>The program measures the decrease (or possible increase) in kW/ton from this first reset. It then determines what the next reset should be.</p> <p>For the condenser water reset, the greater the value, the lower the temperature. We recommend you set this value between 5 (deg) and 7(deg) for setup. The first reset must be different from your resting approach temperature described in <i>Section 3 Condenser Water Setpoint Reset</i> (page 87).</p>	<p>D: 6 (deg) R: 4 to 8 (deg)</p>
<p><b>Input Smoothing and System Response Time</b></p>	
<p><b>Input Smoothing (0=min : 100=max):</b> – This setting smooths the (kW/Ton) input and removes erratic signals.</p> <p>This smoothing is more complex and subtle than most. It does not overly smooth the signal, but rather adjusts without shifting the output too much.</p> <p>Input settings:</p> <p>0 - no smoothing</p> <p>1 - automatic minimal smoothing</p> <p>Up to 100 (maximum smoothing or dampening)</p>	<p>D: 50 R: 0 to 100</p>

Point Name/Description	Range
<p><b>System Response time in minutes (3=min to 30=max): __ minutes</b> The response time period of the building to react to each reset temperature change. If set to less than the actual system response time, then the reset could search and not be accurate.</p> <p>Current interval time is: __:__ minutes and __. __ seconds. — Displays values.</p> <p> <b>CAUTION</b> Critical setting.</p> <p>You set the time it takes for the condenser water system to respond after the optimization program resets the temperature. The program must perceive if the system is using less energy after the setpoint has changed and after the system has settled to the new setpoint.</p> <p>The following occur during the response time:</p> <ul style="list-style-type: none"> <li>Condenser water temperature reaches the new temperature</li> <li>Cooling tower fans stabilize</li> <li>Pumps reach their new speed</li> </ul> <p>The response time is difficult to approximate. If you have access to the entire system, you can trend various points to approximate time.</p> <p><b>NOTES</b></p> <p>Remote towers (for example, if they are on the roof) response time may be between 5 and 10 minutes.</p> <p>Towers next to the mechanical room may be between 3 and 5 minutes.</p>	<p>D: 8 minutes</p> <p>R: 3 to 30 minutes</p>
<p><b>Minimum and Maximum Reset Increments &amp; Algorithm Reset Gain</b></p> <p>Each response period, the program determines the next reset signal that lowers energy demand most effectively. The program outputs a reset signal between 0 and 10 (deg) (0 (deg) = no reset or warmest condenser water temperature, 10 (deg) = the maximum or coolest temperature).</p> <p><b>EXAMPLE</b> The program is producing a 5.4 (deg) reset signal. The next time it resets, in order to minimize energy use, it either adds to the signal, by lowering the condenser water temperature, or subtracts from the signal, by raising the temperature. Each reset increment falls between the allowed minimum and maximum.</p> <p>The actual reset value is based on the reset gains and measurements of the curve profile. If the program is currently producing a 5.4 (deg) reset, and the next reset increment is determined to be 1.1 (deg), then the next reset output will be (5.4 (deg) + 1.1 (deg)) = 6.5 (deg). This is converted to the actual condenser water approach setpoint.</p> <p><b>NOTE</b> The reset increment should be large enough for the system to register the reset temperature and react to it – but not so large that it creates instability. If the temperature increment is too small, the system won't experience enough temperature change to determine if it saves energy.</p>	
<p><b>Adjust Reset Increments below:</b></p>	

Point Name/Description	Range
<p><b>Minimum Reset Increment: __ (deg) (output units: 0-10)</b> – The minimum allowed output increment for each response interval.</p> <p>Current reset increment is: __ – Displays value.</p> <p><b>EXAMPLE</b> If you set this value to 1.0 (deg), the program resets no less than that for each increment. This does not necessarily equal the actual reset at the chiller, which may have a range of 42°F to 54°F. Unless the 0-10 (deg) signal is exactly the 10°F temperature range, the minimum increment may not equal the actual temperature increment. With a range of 42°F to 54°F, each reset degree is <math>(54^\circ - 42^\circ F) / 10 = 1.2^\circ F</math> degrees.</p>	<p>D: 1</p> <p>R: 0.75 to 1.25</p>
<p><b>Maximum Reset Increment: __ (deg) (output units: 0-10)</b> – The maximum allowed output increment for each response interval.</p> <p><b>EXAMPLE</b> If you set it to 1.5 (deg), it resets no more than 1.5 (deg) for each increment. This does not necessarily equal the actual condenser water approach temperature.</p>	<p>D: 2</p> <p>R: 1.25 to 2.0</p>
<b>Adjust Reset Gains below:</b>	
<p><b>Reset Increment Coarse Gain (1=min to 10=max)</b> – Determines how large each reset increment will be. The program applies the gain to various measurements of the efficiency curve, and determines the next increment size. The larger the gain, the larger the increment. However, no matter how small or large the gain, the increment can be no less than the minimum increment and no more than the maximum increment.</p>	<p>D: 5</p> <p>R: 1 to 10</p>
<p><b>Reset Increment Fine Gain (0=min to 10=max)</b> – A fine gain that is added to each increment. It can be combined with the above reset increment to configure the best gain applied to each increment.</p> <p>More is described about how to set up the gain in the <i>Start-up and Commissioning</i> (page 31) section.</p>	<p>D: 0</p> <p>R: 0 to 10</p>
<p><b>Bias for reset of CWS temperature setpoint for cooler temperatures - (only if desired, not a requirement)</b></p> <p>The program functions without applying bias. However, there are times that the kW/ton input can be erratic. Adding bias toward cooler condenser water temperatures promotes energy savings at the chiller even though the condenser water reset temperatures may not be the most effective supply temperature for the system.</p> <p><b>EXAMPLE</b> The program is very close to resetting toward a cooler temperature, but not close enough, and still wants to reset for warmer temperatures. The bias shifts the decision slightly toward resetting for cooler temperatures. Energy savings are biased toward the chiller rather than the towers.</p> <p><b>NOTE</b> Bias is not a required setting.</p>	
<p><b>Add a small bias for reset toward cooler CWS temps?</b> – Turn On for a bias for cooler temperatures.</p>	<p>D: Off</p> <p>R: Off/On</p>
<p><b>Add an additional small bias for reset toward cooler CWS temps:</b> – Adds a fine adjustment to the small bias (above). Turn <b>On</b> to increase bias for cooler temperatures and adjust the gain between 0 and 10.</p>	<p>D: Off</p> <p>R: Off/On</p>
<p><b>Fine gain for bias for reset toward cooler CWS temps (0=min to 10=max)</b> – Adds another fine adjustment to the small bias above, increases bias for cooler temperatures, and adjusts the gain between 0 and 10.</p>	<p>D: 5</p> <p>R: 0 to 10</p>

## Section 3 - Condenser Water Setpoint Reset - Output & Limit Settings

Navigation: i-Vu®

Properties > Control Program > Condenser Water Temperature Optimizer > Section 3 - Condenser Water Setpoint Reset - Output & Limit Settings

Point Name/Description	Range
<b>Condenser Water Supply Setpoint Range – Based on OA Wet Bulb Temperature</b>	
<b>Maximum Wet Bulb Approach __ degrees</b> – The approach when the reset is at its lowest - equivalent to the tower fans running slower as the condenser water temperature setpoint is warmer.	D: 12 °F R: 9 to 12 °F
<b>Resting Wet Bulb Approach __ degrees</b> – The default approach, or base condenser water temperature setpoint, when the optimization program is off. The general default is set close to, but not below, the tower design efficiency. It can be any value between the maximum and minimum approach.  <b>EXAMPLE</b> The resting approach may be 7 °F above wet bulb temperature, which is appropriate, since it is between a high of 12 °F and a low of 5 °F.	D: 8 °F R: 7 to 9 °F
<b>Resting: Use CWS Setpoint: __ degrees</b> – The default temperature or resting condenser water temperature setpoint, when the optimization program is off.	D: 75 °F R: 72 to 78 °F
<b>Instead of the "Resting Wet Bulb Approach" above?</b>	D: NO R: NO/YES
<b>Minimum Wet Bulb Approach __ degrees</b> – The approach when the reset is at its highest. This is the same as tower fans running faster as the condenser water temperature setpoint is coolest.	D: 5 °F R: 4 to 7 °F
<b>Condenser Water Supply Temperature – High Limits</b>  To prevent chiller surge and other high condenser water temperature issues, high temperature limits are established by the following:	
<ul style="list-style-type: none"> <li>• Outside Air Ratio – As the outside air wet bulb temperature rises, set a ratio to limit the condenser water supply temperature</li> <li>• Simple high temperature limit – Do not allow the condenser water temperature to rise above a specific setpoint.</li> </ul>	
<b>NOTE</b> These safeties are not meant to work as primary high limit safeties. You also need high limit safeties at the cooling tower or the facility's local cooling tower program.	
<b>Vary condenser water supply temperature high limit based on outdoor air wet bulb temperature</b>	
<b>As outdoor air wet bulb temperature rises (from __ degrees...</b>	D: 78 °F R: 70 to 80 °F
<b>...to __ degrees)</b>	D: 85 °F R: 80 to 90 °F
<b>Limit condenser water supply temperature (from __ degrees...</b>	D: 79 °F R: 76 to 82 °F

Point Name/Description	Range
...to __ degrees)	D: 75 °F R: 72 to 77 °F
<b>Allow condenser water temperature setpoint to rise no higher than __ degrees</b>	D: 79 °F R: 75 to 84 °F
<p><b>Condenser Water Supply Temperature – Low Limits</b>—This program will apply the highest of the following methods:</p> <p><b>NOTES</b></p> <ul style="list-style-type: none"> <li>To help prevent oil migration, minimum pressure across the orifice plate, and other low-lift issues, the condenser water temperature is given low temperature limits.</li> <li>These safeties are not meant to work as primary low-limit safeties. You still need low limit safeties at the cooling tower or the facility's local cooling tower program</li> <li>The condenser water supply temperature will not drop below the highest of the lowest limits. So, the highest limit is the governing limit.</li> </ul>	
<p><b>Method 1</b></p> <p>There are 3 low limit temperatures based on chiller capacity: Low limit temperature at 20%, 50%, and 100% of chiller operating capacity.</p> <p>The temperatures are linearly interpolated between these points. If the low limit temperature profile is not known, set the same low limit temperature for each.</p>	
<b>Low CWS Temp. Setpoint limit at 20% Chiller capacity: __ degrees</b>	D: 57 °F R: 55 to 78 °F
<b>Low CWS Temp. Setpoint limit at 50% Chiller capacity: __ degrees</b>	D: 56 °F R: 55 to 80 °F
<b>Low CWS Temp. Setpoint limit at 100% Chiller capacity: __ degrees</b>	D: 58 °F R: 55 to 80 °F
<p><b>Method 2</b></p> <p>The condenser water temperature low limit varies based on chiller operating capacity and chilled water supply temperature setpoint. The goal is to have enough pressure across the orifice plate (expansion mechanism) to maintain sufficient refrigeration. This is accomplished by maintaining a low minimum delta temperature between chilled water supply and condenser water supply (condenser water supply temperature – chilled water supply temperature setpoint). The delta temperature varies according to capacity.</p> <ul style="list-style-type: none"> <li>Low Load – Optimizer running at minimum allowable load 20% default – CWS Setpoint = CHWS Setpoint + 10 °F (adj)</li> <li>High Load – Optimizer running at maximum allowable load 90% default – CWS Setpoint = CHWS Setpoint + 30 °F (adj)</li> </ul> <p>The delta temperature varies with the square of capacity between these points. If the low limit temperature profile is unknown, input the default. If the profile is unknown, you can keep the defaults. If you want to disable this feature, enter 0 °F for both.</p>	

Point Name/Description	Range
<b>Low CWS Temp. Setpoint limit at Low Load = CHWS Setpoint + __ degrees</b>	D: 10°F R: 10 to 30°F
<b>Low CWS Temp. Setpoint limit at High Load = CHWS Setpoint + __ degrees</b>	D: 30°F R: 20 to 40°F
<b>Method 3</b> — This is a simple low limit.	
<b>Allow condenser water temperature setpoint to drop no lower than: __ degrees</b>	D: 55°F R: 53 to 75°F
<b>Current Limits, Approach, Setpoints, and CWS Temperature Setpoint</b>  <b>Current High Limit is:</b> — Displays value. <b>Current High Approach is:</b> — Displays value. <b>Current Setpoint is:</b> — Displays value. <b>Current Low Approach is:</b> — Displays value. <b>Current Low Limit is:</b> — Displays value.	

## Electric Metering - Combined kW of Monitored Equipment

Navigation: i-Vu®

**Properties > Control Program >  
Electric Metering - Combined kW of Monitored Equipment**

Point Name/Description	Range
<b>Meter Input</b>	
<b>Instantaneous Demand: __ kW</b> — Displays value of the instantaneous demand read by meters.	
<b>Alarm:</b> <b>IN FAIL</b> — Displays the status of the meter input based on the criteria selected below <b>Send Alarm if meter Input &lt; x</b> with hysteresis of <b>y</b> for greater than <b>_:__ mm:ss</b> Where: <ul style="list-style-type: none"> <li>• x = alarm threshold in Kw</li> <li>• y = hysteresis amount</li> <li>• <b>_:__ mm:ss</b> = delay time in minutes and seconds</li> </ul>	D: 30:00 mm:ss R: 10:00 to 60:00 mm:ss
<b>Reset History</b>  <b>Reset ALL values to zero?</b> — Provides the ability to reset all meter data and history	D: No R: No/Yes



Point Name/Description	Range
<p><b>Peak Demand History</b> – Displays the historical peak kW demand values recorded for various periods. Each period also indicates the time, date, and day of the occurrence <i>since the beginning of the evaluation period.</i></p> <p>The following time period values are displayed in this format:</p> <p>    __._ Kw on __ (hh:mm) on __/__/__ (mm/dd/yy) / day of the week  <b>since</b>      __:__ (hh:mm) on __/__/__ (mm/dd/yy) / day of the week</p>	
<p><b>Daily Peak Demand</b></p> <p>    <b>Today</b> – Displays values and times in the above format.</p> <p>    <b>Previous Day</b> – Displays values and times in the above format.</p>	
<p><b>Monthly Peak Demand</b></p> <p>    <b>Month-To-Date</b> – Displays values and times in the above format.</p> <p>    <b>Previous Month</b> – Displays values and times in the above format.</p>	
<p><b>Yearly Peak Demand</b></p> <p>    <b>Year-To-Date</b> – Displays values and times in the above format.</p> <p>    <b>Previous Year</b> – Displays values and times in the above format.</p>	
<p><b>Usage History</b> – Displays the historical accumulated energy usage values recorded for the following periods.</p>	
<p><b>Daily Usage</b></p> <p>    <b>Today</b> – Displays kWh values.</p> <p>    <b>Previous Day</b> – Displays kWh values.</p>	
<p><b>Monthly Usage</b></p> <p>    <b>Month-To-Date</b> – Displays kWh values.</p> <p>    <b>Previous Month</b> – Displays kWh values.</p>	
<p><b>Yearly Usage</b></p> <p>    <b>Year-To-Date</b> – Displays kWh values.</p> <p>    <b>Previous Year</b> – Displays kWh values.</p>	

## Appendix C: Network Points List for Chilled Water System Optimizer

Equipment	Data point description	Option (O) or Required (X)	Description	Point Type	Comment
<b>Chilled Water Plant</b>					
	Tons of cooling	O	Calculated Cooling Tons	ANI	If available, can be read from a BTU meter. If not, Optimizer will calculate Tons using CHW flow & delta T
	Chiller system on/off	X	System CHW Plant Start/Stop	BNI	
	Chilled water flow rate	X	Total System CHW Flow	ANI	On Pri/Sec systems, use Sec Loop Flow
	Condenser water flow rate	O	Total System CW Flow	ANI	Optional. Can be used for system analysis.
	System CHW Setpoint	X	System CHW Setpoint	ANO	This value is optimized CHW setpoint value and is pushed down to the incumbent control system.
	CHW Setpoint Heartbeat	O	CHW setpoint comm verification signal to incumbent BAS	ANO	Optional. This value is used to confirm communications between the Optimizer and the base control system. It is available in the base control system if using Carrier ChillerVu control logic, or modified i-Vu® logic. Third party usage will require modification to the third party control logic.
	System CW Setpoint	X	System CW Setpoint	ANO	This value is optimized CW setpoint value and is pushed down to the incumbent control system.
	CW Setpoint Heartbeat	O	CW setpoint comm verification signal to incumbent BAS	ANO	Optional. This value is used to confirm communications between the Optimizer and the base control system. It is available in the base control system if using Carrier ChillerVu control logic, or modified i-Vu® logic. Third party usage will require modifying to the third party control logic.
	Chilled water supply temperature set point	O	System CHW Setpoint	ANI	Optional. Can be used to monitor the effective CHW setpoint, or can be used by the Optimizer such that it starts its setpoint calculations from current setpoint.
	Chilled water supply temperature	X	Loop CHW Supply Water Temp	ANI	On Pri/Sec systems, use Sec Loop Temps
	Chilled water return temperature	X	Loop CHW Return Water Temp	ANI	On Pri/Sec systems, use Sec Loop Temps
	Condenser water supply temperature	O	Common CW Supply Temp	ANI	
	Condenser water return temperature	O	Common CW Return Temp	ANI	
	Condenser water supply temperature set point	O	System CW Setpoint	ANI	Optional. Can be used to monitor the effective CW setpoint.
<b>Chillers (Max 8)</b>					
	Chiller power	X	Power input per chiller	ANI	Inputs can be either amps or kW
	Chiller status	X	Chiller run status	BNI	

Equipment	Data point description	Option (0) or Required (X)	Description	Point Type	Comment
<b>Chilled water pumps (Max 20)</b>					
	CHW pump power	X	Power per pump	ANI	Optimizer supports a maximum of 20 kW inputs, and 20 amp inputs Total of ALL CHW pumps (max number is the sum of all pumps; primary, secondary, tertiary)
Condenser water pumps (Max 20)					
	CW pump power	X	Power per pump	ANI	Optimizer supports a maximum of 10 kW inputs, and 10 amp inputs
Cooling tower fans (Max 20)					
	Cooling tower fan power	X	Power per tower	ANI	Optimizer supports a maximum of 10 kW inputs, and 10 amp inputs
<b>Air handler units (Max 40)</b>					
	AHU fan power	X	Power per fan	ANI	Optimizer supports a maximum of 20 kW inputs, and 20 amp inputs
	Return air humidity or area relative humidity	0	RARH from each of the 20 AHUs or representative area relative humidity values	ANI	Optimizer supports up to 20 RH Inputs
<b>Weather</b>					
	Outside air temperature	X		ANI	
	Outside air relative humidity	X		ANI	

## Document revision history

Important changes to this document are listed below. Minor changes such as typographical or formatting errors are not listed.

<b>Date</b>	<b>Topic</b>	<b>Change description</b>	<b>Code*</b>
6/25/19	Installing the controller into an i-Vu® Control System	Deleted references to Snap. You can only create a control program in EquipmentBuilder.	AC-PM-BL-E
3/11/19	BACnet firewall	Changed "prevents the controller from receiving BACnet messages" to "prevents the controller from responding to BACnet messages".	X-PM-KC-O
	Specifications	Reworded Rnet port specification and added power supplied by Rnet port. Added surge CAUTION to Protection specification.	X-TS-AK-E-CC
	Entire document	Updated for v2. Included: <ul style="list-style-type: none"> <li>• Allow optimizer to start from the system current chilled water supply setpoint, rather than it's predefined setpoint</li> <li>• New graphics and download for i-Vu® v7</li> <li>• Manual Intervention to accommodate Union or other worker requirements</li> <li>• Converted optimizer enable, chilled water reset enable, condenser water reset enable, and pauses to network binaries for possible remote enables. Permits ice water storage, thermal storage, and water side economizer controls.</li> </ul>	X-AE-CM-E-WB
	To communicate through the local access port	Removed HyperTerminal - outdated software.	X-D
	Wiring for third party protocols To wire a BACnet over Ethernet network	Removed BACnet over Ethernet from document - not supported.	A-AE-BL-E-BK
	Appendix B: The Commissioning View of the Properties > General conditions and & Status	Section 4 - Optimizer Change Mode – added the option to manually change setpoints	AC-AE-CM-E-BL
	Appendix B: The Commissioning View of the Properties > Chilled Water Temperature Optimizer Reset	Section 3 - Manual Overrides of Chilled Water Reset - and other Settings – added option to use the current chilled water setpoint as the optimizer's starting setpoint.	AC-AE-CM-E-BL
	Appendix C: Network Points List for controller	New topic.	AC-AE-BL-E

\* For internal use only







CARRIER CORPORATION ©2019

A member of the United Technologies Corporation family · Stock symbol UTX · Catalog No. 11-808-574-01 · 6/25/2019



# Anzures

Sistemas de Control  
Edificios inteligentes

Vidal 4819 PB  
C1429AIM - C.A.B.A.  
Tel:011-3529-4390  
ivupro@anzures.com.ar

**EXPERTOS EN CONTROLES**

[www.anzures.com.ar](http://www.anzures.com.ar)